



Orthodontic Product Catalogue

International Version 2

www.tocdental.com

TOC
discover the difference



Ghost™ Advanced Sapphire Brackets

Sapphire aesthetics with polycrystalline strength and durability

Recent advancements in manufacturing techniques and developments in materials have led to the exciting introduction of our new Ghost bracket. With extraordinary aesthetics, Ghost provides precision and control with superior performance features that can only be achieved with highly sophisticated ceramic injection moulding technology. The result is a truly remarkable bracket system that takes aesthetics, performance and durability to unprecedented heights.

- Brilliant aesthetics without the glare of conventional sapphire brackets
- Exceptional strength and fracture resistance
- Significantly less friction than other sapphire brackets providing shorter treatment times

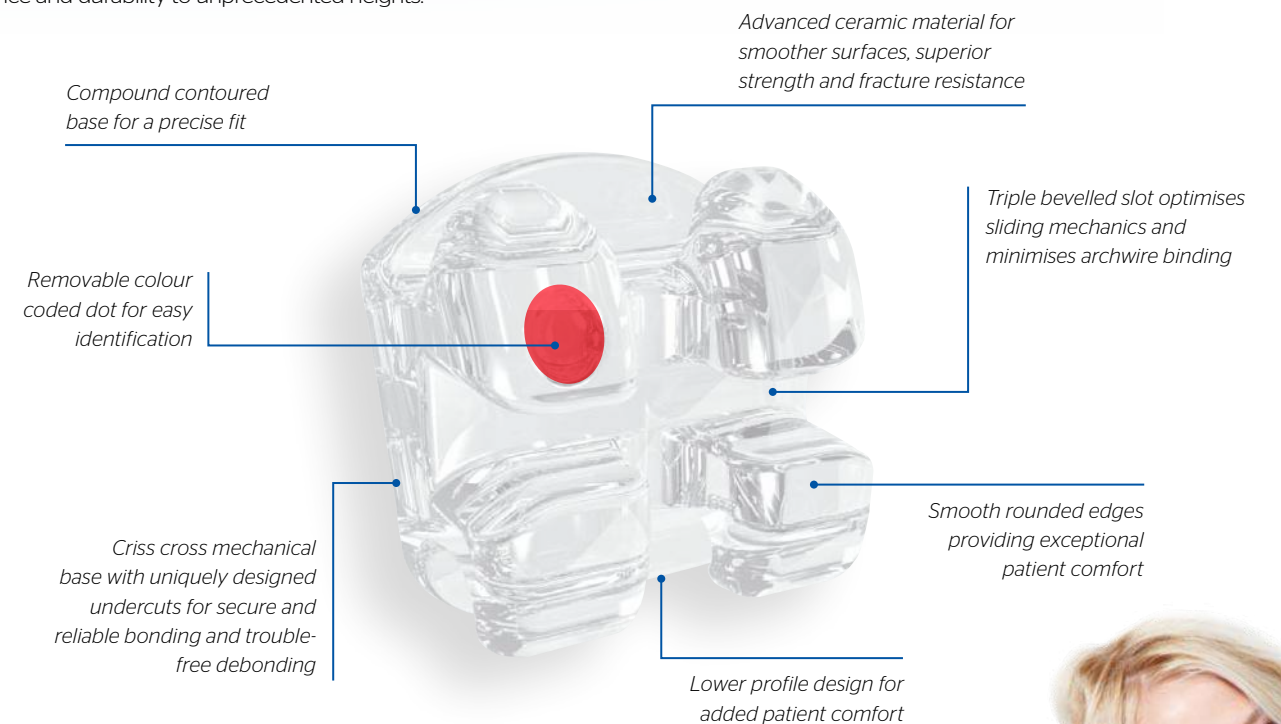

*TOC versions of Roth and MBT prescriptions are not implied to be an exact version of any other system, nor do we claim any endorsement of the Doctors

ROTH* .022"	T	A	R	RIGHT	LEFT
U1	12°	5°	0	BG-112-00	BG-212-00
U2	8°	9°	0	BG-122-00	BG-222-00
U3 + Hook	0°	11°	4M	BG-132-10	BG-232-10
U4/5	-7°	0°	0	BG-542-00	
L1/2	0°	0°	0	BG-612-00	
L3 + Hook	-11°	5°	2M	BG-332-10	BG-432-10
L4	-17°	0°	0	BG-642-00	
L5	-22°	0°	0	BG-652-00	

MBT* .022"	T	A	R	RIGHT	LEFT
U1	17°	4°	0	BG-112-40	BG-212-40
U2	10°	8°	0	BG-122-40	BG-222-40
U3 + Hook	0°	8°	0	BG-132-41	BG-232-41
U4/5	-7°	0°	0	BG-142-40	
L1/2	-6°	0°	0	BG-312-40	
L3 + Hook	0°	3°	0	BG-332-41	BG-432-41
L4	-12°	0°	0	BG-342-40	
L5	-17°	0°	0	BG-352-40	



BRACKET KITS	ROTH* .022"	MBT* .022"
Upper 5-5 + Hooks	KITBG-055-15	KITBG-055-45
Upper/Lower 5-5 + Hooks	KITBG-055-10	KITBG-055-50

MARKETING	CODE
Patient Leaflets (Pk 25)	BG-120-01
A2 Poster	BG-120-02
Consultation Model	BG-TYP-00



discover the difference

Welcome to The Orthodontic Company - TOC

Founded in 1992, TOC is proud to be among the UK's largest orthodontic companies. We have been supplying our comprehensive range of products to the international market for a number of years.

High quality products at value for money prices have always been the aim of TOC in over 26 years of history supplying the orthodontic profession. We are an ISO:9001:2015 accredited company and we continually assess the quality of the products we supply to ensure the highest standard.

Vast stocks are held in our UK distribution centre ready for immediate shipment and 24 hour international deliveries if required. We strive to provide the very best customer service and our experienced team are always ready to help with any questions you may have.

TOC is an experienced orthodontic company and having worked for many years with some of the largest manufacturers in the world, we know what it takes to succeed in a competitive market.

We look forward to serving you with all your orthodontic requirements.

International Sales
T: +44 117 975 5533
E: export@tocdental.com

Table of Contents

- Aesthetic Brackets **03**
- Metal Brackets **06**
- Molar Bands **09**
- Buccal Tubes **10**
- Archwires & Accessories **11**
- Attachments **18**
- Elastomers **20**
- Elastics **22**
- Bonding Supplies **23**
- Cheek Retractors **25**
- Impression Supplies **26**
- Mirrors **27**
- Vacuum Forming **28**
- Interproximal Reduction & Burs **29**
- Instruments **30**
- Patient Care **37**
- Index **38**
- Terms & Conditions **39**



Verve™ Ceramic Brackets

Experience everything Verve has to offer - precision, strength and reliability.

Verve Ceramic are almost invisible as they have the highest translucency, blending naturally with all tooth shades and are highly resistant to staining and discolouration. Verve Ceramic are manufactured from the highest quality polycrystalline alumina providing unmatched strength and durability to minimise bracket fracture. The proven mechanical lock base design ensures optimal bond strength whilst also making debonding predictable and stress free. Clinically proven, Verve Ceramic will deliver exactly what you and your patients are looking for in an aesthetic bracket system.

- Made from the highest quality polycrystalline alumina for strength and durability
- High translucency to blend naturally with all tooth shades
- Resistant to staining and discolouration
- Smooth archwire slot improves sliding mechanics
- Proven mechanical lock base with dove tail grooves for optimal bond strength and predictable debonding



ROTH* .022"	T	A	R	RIGHT	LEFT
U1	12°	5°	0	BV-112-00	BV-212-00
U2	8°	9°	0	BV-122-00	BV-222-00
U3	0°	11°	4m	BV-132-00	BV-232-00
U3 + Hook	0°	11°	4m	BV-132-10	BV-232-10
U4/5	-7°	0°	0	BV-542-00	
U4/5 + Hook	-7°	0°	0	BV-542-10	
L1/2	0°	0°	0	BV-612-00	
L3	-11°	5°	2m	BV-332-00	BV-432-00
L3 + Hook	-11°	5°	2m	BV-332-10	BV-432-10
L4	-17°	0°	0	BV-642-00	
L4 + Hook	-17°	0°	0	BV-642-10	
L5	-22°	0°	0	BV-652-00	
L5 + Hook	-22°	0°	0	BV-652-10	

MBT* .022"	T	A	R	RIGHT	LEFT
U1	17°	4°	0	BV-112-40	BV-212-40
U2	8°	9°	0	BV-122-40	BV-222-40
U3	0°	11°	0	BV-132-40	BV-232-40
U3 + Hook	0°	11°	0	BV-132-41	BV-232-41
U4/5	-7°	0°	0	BV-542-40	
U4/5 + Hook	-7°	0°	0	BV-542-41	
L1/2	-6°	0°	0	BV-612-40	
L3	-12°	0°	0	BV-332-40	BV-432-40
L3 + Hook	-11°	5°	0	BV-332-41	BV-432-41
L4	-17°	0°	0	BV-342-40	BV-442-40
L4 + Hook	-17°	0°	0	BV-342-41	BV-442-41
L5	-17°	0°	0	BV-352-40	BV-452-40
L5 + Hook	-17°	0°	0	BV-352-41	BV-452-41

*TDC versions of Roth and MBT prescriptions are not implied to be an exact version of any other system, nor do we claim any endorsement of the Doctors

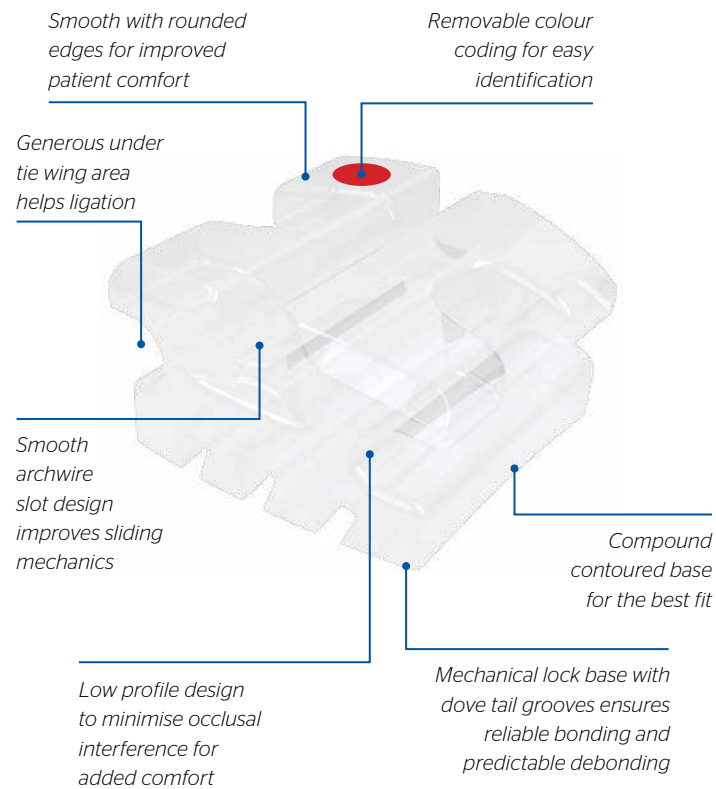

BRACKET KITS	ROTH* .022"	MBT* .022"
Upper/Lower 5-5	KITBV-055-20	KITBV-055-40
Upper/Lower 5-5 + Hooks on 3	KITBV-055-23	KITBV-055-43
Upper/Lower 5-5 + Hooks on 3, 4, 5	KITBV-055-25	KITBV-055-45
Upper 5-5 + Hooks on 3	KITBV-055-26	KITBV-055-46
Verve Consultation Model	BV-TYP-00	

Envy™ Composite Brackets

First choice for value and reliability

Envy is a great alternative to ceramic brackets providing a low cost aesthetic solution for your patients. Highly translucent, Envy blends well with all tooth shades creating a natural appearance and is stain resistant to provide superb aesthetics. Manufactured from the highest quality polyurethane to create a strong bracket resistant to breakage.

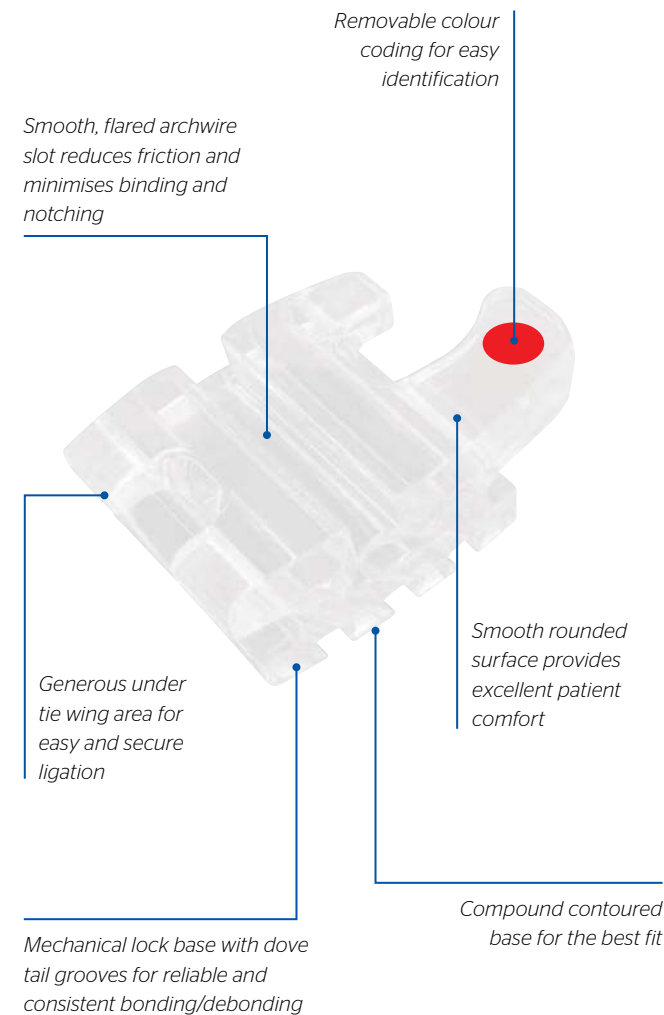

*TDC versions of Roth and MBT prescriptions are not implied to be an exact version of any other system, nor do we claim any endorsement of the Doctors



ROTH* .022"	T	A	R	RIGHT	LEFT
U1	12°	5°	0	BE-112-00	BE-212-00
U2	8°	9°	0	BE-122-00	BE-222-00
U3	0°	11°	0	BE-132-00	BE-232-00
U3 + Hook	0°	11°	0	BE-132-10	BE-232-10
U4/5	-7°	0°	0	BE-542-00	
U4/5 + Hook	-7°	0°	0	BE-542-10	
L1/2	0°	0°	0	BE-612-00	
L3	-11°	5°	2m	BE-332-00	BE-432-00
L3 + Hook	-11°	5°	0	BE-332-10	BE-432-10
L4	-17°	0°	0	BE-642-00	
L5	-22°	0°	0	BE-652-00	

MBT* .022"	T	A	R	RIGHT	LEFT
U1	17°	4°	0	BE-112-40	BE-212-40
U2	10°	8°	0	BE-122-40	BE-222-40
U3	-7°	8°	0	BE-132-40	BE-232-40
U3 + Hook	-7°	8°	0	BE-13241	BE-232-41
U4/5	-7°	0°	0	BE-542-40	
U4/5 + Hook	-7°	0°	0	BE-542-41	
L1/2	-6°	0°	0	BE-612-40	
L3	-12°	0°	0	BE-332-40	BE-432-40
L3 + Hook	-12°	0°	0	BE-332-41	BE-432-41
L4	-17°	0°	0	BE-342-40	BE-442-40
L5	-17°	0°	0	BE-352-40	BE-452-40

BRACKET KITS	ROTH* .022"	MBT* .022"
Upper/Lower 5-5	KITBE-055-20	KITBE-055-40
Upper/Lower 5-5 + Hooks on 3	KITBE-055-23	KITBE-055-43
Upper/Lower 5-5 + Hooks on 3, 4 & 5	KITBE-055-25	KITBE-055-45
Envy Consultation Model	BE-TYP-00	

Verve™

Precision, strength and reliability

Verve is precision engineered to a design that fulfils all your expectations of a high quality bracket. Created to provide great strength and reliability, with features that will allow you to treat with confidence. Now you can really enjoy using Verve and your patients will love them!

Precision Engineered

Verve has an advanced design that combines Metal Injection Moulding (MIM) and Computer Numerator Controlled Milling (CNC). MIM allows for a smaller and more detailed design which has greater strength whilst the CNC milling provides the most accurate of slots for advanced sliding mechanics.

Ease of Use

Verve incorporates many features to help with bracket placement, bonding and ligation of elastomers; the compound contoured Super-Grip™ base means there is no need to worry about accidental debonds. Bracket options include bicuspidis with an offset base making it easier to bond partially erupted teeth while still providing straight wire mechanics. The additional option of an extended bonding pad on pre-molars means the brackets are easier to position as it allows the bracket slot and more of the base to be visible during bonding. Bond strength is also increased with these bases. Bracket kits are conveniently supplied pre-loaded onto bracket orientation cards ready for bonding to save you both time and money.

Treatment Results

Verve provides you with efficient and predictable treatment case after case, with true torque in the base delivering exact bracket prescription values, accurate slots and in/out dimensions with fewer wire bends. Your patients will appreciate the comfort, look and the results too!



Bi-directional canine hook is rounded and smooth for patient comfort

Permanent ID by quadrant with removable colour coding

Chamfered tie wings for ease of ligature placement

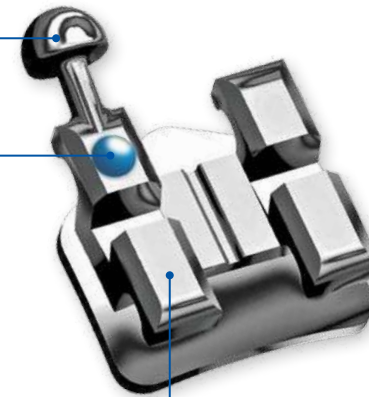

Highly visible vertical scribe line for quick and precise placement

Super polished low friction slot for great sliding mechanics

Smooth tie wings for enhanced patient comfort

Highest grade stainless steel for maximum strength

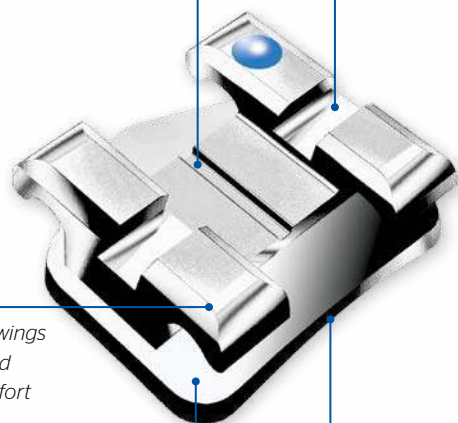

Super-Grip™ 80 Gauge mesh base for maximum bond strength

- CNC milled slot for greater precision and more efficient treatment
- Offset and extended base options to suit your specific requirements
- Compound contouring facilitates placement
- Low profile minimises occlusal interferences
- Palladium alloy brazing for the strongest bracket-to-base bond
- Mushroom shaped hook secures chains and ligatures in place without slipping
- Torque in base for level slot alignment

*TDC versions of Roth and MBT prescriptions are not implied to be an exact version of any other system, nor do we claim any endorsement of the Doctors

ROTH* .022"	T	A	R	RIGHT	LEFT
U1	12°	5°	0	AV-112-00	AV-212-00
U2	8°	9°	0	AV-122-00	AV-222-00
U3	0°	11°	4M	AV-132-00	AV-232-00
U3 + Hook	0°	11°	4M	AV-132-10	AV-232-10
U4	-7°	0°	0	AV-142-00	AV-242-00
U4 Offset	-7°	0°	0	AV-142-13	AV-242-13
U4 Offset + Extended Base	-7°	0°	0	AV-142-15	AV-242-15
U5	-7°	0°	0	AV-152-00	AV-252-00
U5 Offset	-7°	0°	0	AV-152-13	AV-252-13
U5 Offset + Extended Base	-7°	0°	0	AV-152-15	AV-252-15
L1/2	0°	0°	0	AV-312-00	AV-412-00
L3	-22°	-1°	4D	AV-332-00	AV-432-00
L3 + Hook	-22°	-1°	4D	AV-332-10	AV-432-10
L4	-17°	0°	0	AV-342-00	AV-442-00
L4 Offset	-17°	0°	0	AV-342-13	AV-442-13
L4 Offset + Extended Base	-17°	0°	0	AV-342-15	AV-442-15
L5	-22°	0°	0	AV-352-00	AV-452-00
L5 Offset	-22°	0°	0	AV-352-13	AV-452-13
L5 Offset + Extended Base	-22°	0°	0	AV-352-15	AV-452-15

BRACKET KITS	ROTH* .022"
Upper/Lower 5-5	KITAV-055-00
Upper/Lower 5-5 Offset	KITAV-055-03
Upper/Lower 5-5 + Extended Base	KITAV-055-05
Upper/Lower 5-5 + Hooks on 3	KITAV-055-10
Upper/Lower 5-5 + Hooks on 3, Offset	KITAV-055-13
Upper/Lower 5-5 + Hooks on 3 Offset, Extended Base	KITAV-055-15
Upper/Lower 5-5 + Hooks on 3, 4 & 5	KITAV-055-17

TREAT YOUR PATIENTS WITH VERVE!

- Guaranteed ease of use
- Treatment efficiency
- Predictable results



MBT* .022"	T	A	R	RIGHT	LEFT
U1	17°	4°	0	AV-112-40	AV-212-40
U2	10°	8°	0	AV-122-40	AV-222-40
U3	0°	9°	0	AV-132-40	AV-232-40
U3 + Hook	0°	9°	0	AV-132-41	AV-232-41
U4	-7°	0°	0	AV-142-40	AV-242-40
U4 Offset	-7°	0°	0	AV-142-43	AV-242-43
U4 Offset + Extended Base	-7°	0°	0	AV-142-45	AV-242-45
U5	-7°	0°	0	AV-152-40	AV-252-40
U5 Offset	-7°	0°	0	AV-152-43	AV-252-43
U5 Offset + Extended Base	-7°	0°	0	AV-152-45	AV-252-45
L1/2	-6°	0°	0	AV-312-40	AV-412-40
L3	-6°	3°	0	AV-332-40	AV-432-40
L3 + Hook	-6°	3°	0	AV-332-41	AV-432-41
L4	-12°	2°	0	AV-342-40	AV-442-40
L4 Offset	-12°	2°	0	AV-342-43	AV-442-43
L4 Offset + Extended Base	-12°	2°	0	AV-342-45	AV-442-45
L5	-17°	2°	0	AV-352-40	AV-452-40
L5 Offset	-17°	2°	0	AV-352-43	AV-452-43
L5 Offset + Extended Base	-17°	2°	0	AV-352-45	AV-452-45

BRACKET KITS	MBT* .022"
Upper/Lower 5-5	KITAV-055-40
Upper/Lower 5-5 Offset	KITAV-055-43
Upper/Lower 5-5 + Extended Base	KITAV-055-45
Upper/Lower 5-5 + Hooks on 3	KITAV-055-50
Upper/Lower 5-5 + Hooks on 3, Offset	KITAV-055-53
Upper/Lower 5-5 + Hooks on 3 Offset, Extended Base	KITAV-055-55
Upper/Lower 5-5 + Hooks on 3, 4 & 5	KITAV-055-57

Essentials™

Value Stainless Steel Bracket System

Manufactured from advanced 17-4 stainless steel, Essentials brackets offer maximum strength and reliability in performance. Stay in control of your consumable costs by using Essentials.

- **Chamfered Slot Design**
Makes wire insertion easier
- **Ultra Smooth Slot**
For reduced friction and shorter treatment time
- **Rounded Ball Hooks**
Helps improve patient comfort
- **Low Profile**
For added patient comfort
- **Proven 80 Gauge Mesh Base**
For reliable and predictable bonding
- **Centre Scribe Line**
Makes for easy and accurate placement
- **Smooth, Rounded Corners**
Means less tissue irritation



We preload your brackets on orientation cards for you at no extra cost

ROTH* .022"	T	A	R	RIGHT	LEFT
U1	12°	5°	0	AE-112-00	AE-212-00
U2	8°	9°	0	AE-122-00	AE-222-00
U3	0°	11°	4M	AE-132-00	AE-232-00
U3 + Hook	0°	11°	4M	AE-132-10	AE-232-10
U4	-7°	0°	0	AE-542-00	
U5	-7°	0°	0	AE-552-00	
L1/2	0°	0°	0	AE-312-00	AE-412-00
L3	-11°	5°	0	AV-332-00	AV-432-00
L3 + Hook	-11°	5°	0	AE-332-10	AE-432-10
L4	-17°	0°	0	AE-642-00	
L5	-22°	0°	0	AE-652-00	

MBT* .022"	T	A	R	RIGHT	LEFT
U1	12°	5°	0	AE-112-40	AE-212-40
U2	8°	9°	0	AE-122-40	AE-222-40
U3	0°	11°	4M	AE-132-40	AE-232-40
U3 + Hook	0°	11°	4M	AE-132-41	AE-232-41
U4/5	-7°	0°	0	AE-142-40	AE-242-40
L1/2	0°	0°	0	AE-312-40	AE-412-40
L3	-11°	5°	0	AE-332-40	AE-432-40
L3 + Hook	-11°	5°	0	AE-332-41	AE-432-41
L4	-17°	0°	0	AE-342-40	AE-442-40
L5	-22°	0°	0	AE-352-40	AE-452-40

BRACKET KITS	ROTH* .022"	MBT* .022"
Upper/Lower 5-5	KITAE-055-00	KITAE-055-40
Upper 5-5 + Hooks on 3	KITAE-055-10	KITAE-055-50

essentials™

Verve™

Quality Prewelded Molar Bands

Precision Shaped for a Tight, Secure Fit

Each band is precisely shaped to fit each tooth securely with excellent retention

Hard but Malleable Stainless Steel

Strong enough to avoid wall collapse when fitting, yet is malleable enough for 'snap' fitting that requires little or no burnishing

Increased Buccal Height

For greater flexibility in placement and positioning of buccal tubes and lingual attachments

Micro-Etched Interiors

Provides a rough surface for increased bond strength

Permanently Etched Exterior

For easy identification

Anatomically Contoured

Fast placement and accurate fit

Permanent Marking

For easy identification

Straight Interproximal Wall

Makes band seating easy

Comparable 3M Unitek sizes

Rolled Edges

No sharp edges, maximum patient comfort

Ideally Tempered

For easy contouring

Micro-Etched Interior Surface

Ensures maximum retention

Band Conversion chart available

ROTH*	Slot Torque	Distal Offset
.022" Upper	-10°	8°
.022" Lower	-25°	5°

VERVE BANDS™



Upper Combination Convertible with or without Lingual Cleats



Upper Single Convertible with or without Lingual Cleats



Lower Single Convertible with or without Lingual Cleats

MBT*	Slot Torque	Distal Offset
.022" Upper	-14°	10°
.022" Lower	-20°	0°

Essentials™

Value 1st Molar Prewelded Bands

- Micro-etched interiors increases bond strength and retention
- Rolled edges for maximum patient comfort
- Anatomically contoured for quick placement and an accurate fit
- Permanent marking system for easy identification
- Ideally tempered allows easy contouring
- Straight interproximal wall makes band seating easy



Single Non-Convertible MBT* .022" Sizes available from 29.5 to 44

1st Molar Band .022"	SIZES	RIGHT	LEFT
Upper	29.5-44	ME-***-15+	ME-***-25+
Lower	29.5-44	ME-***-35+	ME-***-45+

*The TOC versions of these prescriptions are not implied to be an exact version of any other system, nor do we claim any endorsement of the doctors.

Verve™

Precision, strength and reliability

Verve buccal tubes are designed for guaranteed ease of use, treatment efficiency and predictable results.

Verve buccal tubes are precision manufactured for strength and reliability, with a low profile to deliver maximum comfort for your patients.



1st Molar	ROTH*	MBT*	2nd Molar	ROTH*	MBT*
UR6 .022"	DV-162-00	DV-162-40	UR7 .022"	DV-172-00	DV-172-40
UL6 .022"	DV-262-00	DV-262-40	UL7 .022"	DV-272-00	DV-272-40
LR6 .022"	DV-362-00	DV-362-40	LR7 .022"	DV-372-00	DV-372-40
LL6 .022"	DV-462-00	DV-462-40	LL7 .022"	DV-472-00	DV-472-40

Rounded ball hook
For improved patient comfort

Low profile MIM design
Great comfort for patients

Funnelled entry
For easy wire insertion

Indented mesh pad
For precise placement

Torque in the base
For efficient treatment

Permanent code markings
For easy identification

Flat buccal surface
With special cut out aids handling and positioning

80 gauge mesh contoured base
For reliable bonding

Optimum size pad
Ensures maximum retention

Essentials™

Value Bondable Buccal Tubes

Our popular Essentials tubes are precision manufactured for a strong and compact design.

The 80 gauge contoured mesh base makes them easy to position and ensures reliable bonding whilst the chamfered entrance makes archwire placement easy.

- All-in-one structure for maximum strength
- Precision casting for intricate design
- Low profile for patient comfort
- Indented mesh pad for easy placement
- Enlarged archwire entry hole, makes archwire placement easy
- Coloured positioning notch to aid placement

2nd Molar Tubes



1st Molar Tubes



1st Molar .022"	ROTH*	MBT*
UR6	DE-106-00	DE-106-40
UL6	DE-206-00	DE-206-40
LR6	DE-306-00	DE-306-40
LL6	DE-406-00	DE-406-40

2nd Molar .022"	ROTH*	MBT*
UR7	DE-107-00	DE-107-40
UL7	DE-207-00	DE-207-40
LR7	DE-307-00	DE-307-40
LL7	DE-407-00	DE-407-40

essentials™

*The TOC versions of these prescriptions are not implied to be an exact version of any other system nor do we claim any endorsement of the doctors.

Hi-Q™ Archwires

A range of high quality archwires

High quality nickel titanium and thermal nickel titanium wires which are designed to provide a low continuous force, with shape superior memory and elasticity characteristics. Manufactured to precise tolerances, Hi-Q wires offer all the features and benefits you would expect from a high performance wire.



- Super elasticity - very flexible and easy to engage
- Superior shape memory - stays active right throughout treatment
- Low, constant force - for most efficient tooth movement and increased patient comfort
- Polished finish - low friction
- Rigorous quality control - every wire performs the same

Nickel Titanium

EURO (Pk 10)		
Size	Upper	Lower
.012"	HQN-012-00	HQN-012-10
.014"	HQN-014-00	HQN-014-10
.016"	HQN-016-00	HQN-016-10
.018"	HQN-018-00	HQN-018-10
.020"	HQN-020-00	HQN-020-10
.016" x .016"	HQN-616-00	HQN-616-10
.016" x .022"	HQN-622-00	HQN-622-10
.017" x .025"	HQN-725-00	HQN-725-10
.018" x .018"	HQN-818-00	HQN-818-10
.018" x .025"	HQN-825-00	HQN-825-10
.019" x .025"	HQN-925-00	HQN-925-10
.020" x .020"	HQN-220-00	HQN-220-10

Thermal Nickel Titanium

EURO (Pk 10)		
Size	Upper	Lower
.014"	HQ-014-00	HQ-014-10
.016"	HQ-016-00	HQ-016-10
.018"	HQ-018-00	HQ-018-10
.020"	HQ-020-00	HQ-020-10
.016" x .016"	HQ-616-00	HQ-616-10
.016" x .022"	HQ-622-00	HQ-622-10
.017" x .025"	HQ-725-00	HQ-725-10
.018" x .018"	HQ-818-00	HQ-818-10
.018" x .025"	HQ-825-00	HQ-825-10
.019" x .025"	HQ-925-00	HQ-925-10
.020" x .020"	HQ-220-00	HQ-220-10

FULL (Pk 10)		
Size	Upper	Lower
.012"	HQN-012-01	HQN-012-11
.014"	HQN-014-01	HQN-014-11
.016"	HQN-016-01	HQN-016-11
.018"	HQN-018-01	HQN-018-11
.020"	HQN-020-01	HQN-020-11
.016" x .016"	HQN-616-01	HQN-616-11
.016" x .022"	HQN-622-01	HQN-622-11
.017" x .025"	HQN-725-01	HQN-725-11
.018" x .018"	HQN-818-01	HQN-818-11
.018" x .025"	HQN-825-01	HQN-825-11
.019" x .025"	HQN-925-01	HQN-925-11
.020" x .020"	HQN-220-01	HQN-220-11

FULL (Pk 10)		
Size	Upper	Lower
.014"	HQ-014-01	HQ-014-11
.016"	HQ-016-01	HQ-016-11
.018"	HQ-018-01	HQ-018-11
.020"	HQ-020-01	HQ-020-11
.016" x .016"	HQ-616-01	HQ-616-11
.016" x .022"	HQ-622-01	HQ-622-11
.017" x .025"	HQ-725-01	HQ-725-11
.018" x .018"	HQ-818-01	HQ-818-11
.018" x .025"	HQ-825-01	HQ-825-11
.019" x .025"	HQ-925-01	HQ-925-11
.020" x .020"	HQ-220-01	HQ-220-11

UNIVERSAL (Pk 10)	
Size	U/L
.012"	HQN-012-55
.014"	HQN-014-55
.016"	HQN-016-55
.018"	HQN-018-55
.014" x .025"	HQN-425-55
.016" x .025"	HQN-625-55
.018" x .025"	HQN-825-55

UNIVERSAL (Pk 10)	
Size	U/L
.014"	HQ-014-55
.016"	HQ-016-55
.018"	HQ-018-55
.014" x .025"	HQ-425-55
.016" x .022"	HQ-622-25
.016" x .025"	HQ-625-55
.018" x .025"	HQ-825-55

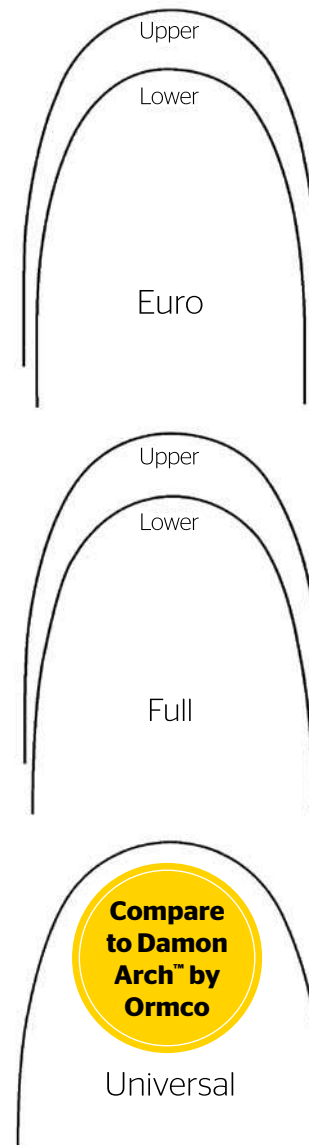

All trademarks are the property of their respective owners

Copper Nickel Titanium

Consistent high quality

The blend of copper in the raw material combined with an advanced manufacturing process provides unique benefits for you and your patients.

The lighter forces and high flexibility of Hi-Q Copper NiTi allows for easier wire engagement in moderate to severely misaligned cases and

reduces patient discomfort. Hi-Q Copper NiTi maintains a constant force and generates more consistent tooth movement as the wire is active for longer in the optimal force range thus allowing fewer archwire changes. The higher the temperature transition, the lower the relative forces delivered by the wire.



EURO (Pk 10)			
Size	Degrees	Upper	Lower
.014"	27°	HQ-014-27EU	HQ-014-27EL
.016"	35°	HQ-016-35EU	HQ-016-35EL
.018"	35°	HQ-018-35EU	HQ-018-35EL
.016" x .022"	35°	HQ-622-35EU	HQ-622-35EL
.017" x .025"	35°	HQ-725-35EU	HQ-725-35EL
.019" x .025"	35°	HQ-925-35EU	HQ-925-35EL
.020" x .020"	35°	HQ-220-35EU	HQ-220-35EL

FULL (Pk 10)			
Size	Degrees	Upper	Lower
.018"	35°	HQ-018-35FU	HQ-018-35FL
.019" x .025"	35°	HQ-925-35FU	HQ-925-35FL

UNIVERSAL (Pk 10)			
Size	Degrees	Without Stops	With Stops
.013"	27°	-	HQ-013-27US
.014"	27°	HQ-014-27U	HQ-014-27US
.018"	27°	HQ-018-27U	HQ-018-27US
.014" x .025"	27°	-	HQ-425-27US
.018" x .025"	27°	HQ-825-27U	HQ-825-27US

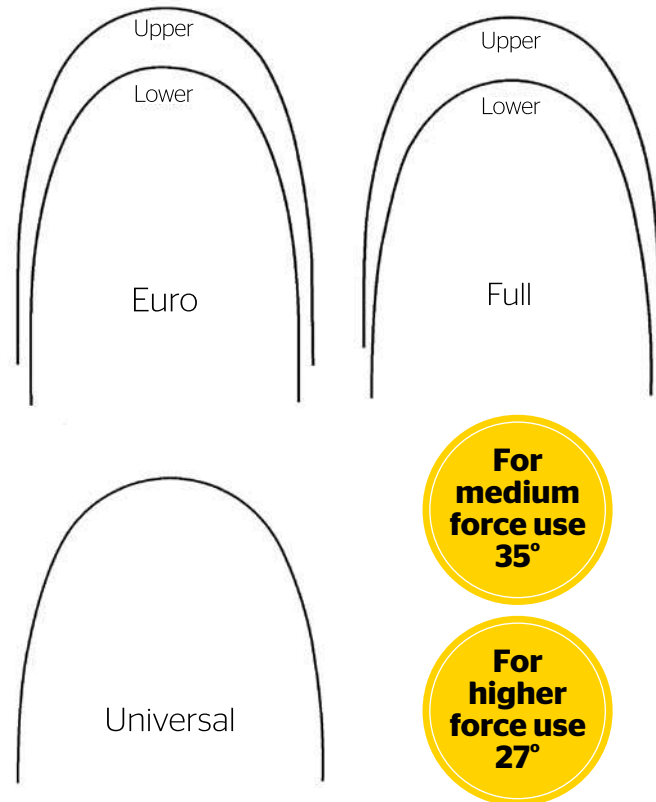

For medium force use 35°

For higher force use 27°

Reverse Curve Nickel Titanium

Hi-Q Reverse Curve NiTi wires offer all the advantages of super elastic continuous force levels combined with the benefits of a reverse curve wire. Designed for opening and closing the bite, they also provide excellent levelling and aligning.



EURO (Pk 10)		
Size	Upper	Lower
.012"	HQR-012-00	HQR-012-10
.014"	HQR-014-00	HQR-014-10
.016"	HQR-016-00	HQR-016-10
.018"	HQR-018-00	HQR-018-10
.020"	HQR-020-00	HQR-020-10
.016" x .016"	HQR-616-00	HQR-616-10
.016" x .022"	HQR-622-00	HQR-622-10
.017" x .025"	HQR-725-00	HQR-725-10
.018" x .018"	HQR-818-00	HQR-818-10
.018" x .025"	HQR-825-00	HQR-825-10
.019" x .025"	HQR-925-00	HQR-925-10
.020" x .020"	HQR-220-00	HQR-220-10
.021" x .025"	HQR-225-00	HQR-225-10

Beta Titanium

Nickel-free treatment

Hi-Q Beta Titanium archwires deliver greater forces than nickel titanium without the same stiffness of stainless steel. They allow you to place larger wire sizes earlier in treatment and increase treatment efficiency.

Hi-Q Beta Titanium offers excellent bendability allowing you to form loops and bends easily. They have a smooth, polished finish for superb sliding mechanics and reduced friction. The wires are also nickel free to prevent any allergic reactions.

EURO (Pk 10)		
Size	Upper	Lower
.016"	HQB-016-00	HQB-016-10
.018"	HQB-018-00	HQB-018-10
.016" x .016"	HQB-616-00	HQB-616-10
.016" x .022"	HQB-622-00	HQB-622-10
.017" x .025"	HQB-725-00	HQB-725-10
.018" x .018"	HQB-818-00	HQB-818-10
.018" x .025"	HQB-825-00	HQB-825-10
.019" x .025"	HQB-925-00	HQB-925-10
.021" x .025"	HQB-225-00	HQB-225-10

FULL (Pk 10)		
Size	Upper	Lower
.016"	HQB-016-01	HQB-016-11
.018"	HQB-018-01	HQB-018-11
.016" x .022"	HQB-622-01	HQB-622-11
.017" x .025"	HQB-725-01	HQB-725-11
.018" x .018"	HQB-818-01	HQB-818-11
.018" x .025"	HQB-825-01	HQB-825-11
.019" x .025"	HQB-925-01	HQB-925-11
.021" x .025"	HQB-225-01	HQB-225-11

UNIVERSAL (Pk 10)	
Size	Upper/Lower
.016" x .025"	HQB-625-55
.017" x .025"	HQB-725-55
.019" x .025"	HQB-925-55

Coated Archwires

Perfect for use with aesthetic brackets

Tooth coloured durable coating which blends well with all aesthetic brackets. The size shown is the finished size. Tooth tone coating adds .002" to the diameter. Available in Euro and Full Arch shapes.



NICKEL TITANIUM - EURO (Pk 10)		
Size	Upper	Lower
.014"	HQC-014-00	HQC-014-10
.016"	HQC-016-00	HQC-016-10
.018"	HQC-018-00	HQC-018-10
.020"	HQC-020-00	HQC-020-10
.016" x .022"	HQC-622-00	HQC-622-10
.018" x .018"	HQC-818-00	HQC-818-10
.018" x .025"	HQC-825-00	HQC-825-10
.019" x .025"	HQC-925-00	HQC-925-10
.020" x .020"	HQC-220-00	HQC-220-10

NICKEL TITANIUM - FULL (Pk 10)		
Size	Upper	Lower
.014"	HQC-014-01	HQC-014-11
.016"	HQC-016-01	HQC-016-11
.018"	HQC-018-01	HQC-018-11
.020"	HQC-020-01	HQC-020-11
.016" x .022"	HQC-622-01	HQC-622-11
.018" x .018"	HQC-818-01	HQC-818-11
.018" x .025"	HQC-825-01	HQC-825-11
.019" x .025"	HQC-925-01	HQC-925-11
.020" x .020"	HQC-220-01	HQC-220-11

STAINLESS STEEL - EURO (Pk 10)		
Size	Upper	Lower
.014"	HQC-014-50	HQC-014-60
.016"	HQC-016-50	HQC-016-60
.018"	HQC-018-50	HQC-018-60
.020"	HQC-020-50	HQC-020-60
.016" x .022"	HQC-622-50	HQC-622-60
.017" x .025"	HQC-725-50	HQC-725-60
.018" x .018"	HQC-818-50	HQC-818-60
.018" x .025"	HQC-825-50	HQC-825-60
.019" x .025"	HQC-925-50	HQC-925-60

STAINLESS STEEL - FULL (Pk 10)		
Size	Upper	Lower
.014"	HQC-014-51	HQC-014-61
.016"	HQC-016-51	HQC-016-61
.018"	HQC-018-51	HQC-018-61
.020"	HQC-020-51	HQC-020-61
.016" x .022"	HQC-622-51	HQC-622-61
.017" x .025"	HQC-725-51	HQC-725-61
.018" x .018"	HQC-818-51	HQC-818-61
.018" x .025"	HQC-825-51	HQC-825-61
.019" x .025"	HQC-925-51	HQC-925-61

Stainless Steel

High quality guaranteed

Manufactured from the highest quality medical grade steel, our popular Hi-Q Stainless Steel Archwires accepts bends without breakage and provides consistent performance.

- High tensile strength
- Polished for reduced friction
- Consistent quality

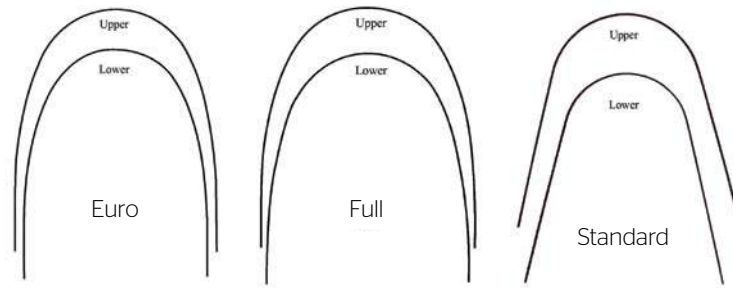

EURO (Pk 100 Round / Pk 10 Rect.)		
Size	Upper	Lower
.012"	HQS-012-00	HQS-012-10
.014"	HQS-014-00	HQS-014-10
.016"	HQS-016-00	HQS-016-10
.018"	HQS-018-00	HQS-018-10
.020"	HQS-020-00	HQS-020-10
.016" x .016"	HQS-616-00	HQS-616-10
.016" x .022"	HQS-622-00	HQS-622-10
.017" x .022"	HQS-722-00	HQS-722-10
.017" x .025"	HQS-725-00	HQS-725-10
.018" x .018"	HQS-818-00	HQS-818-10
.018" x .022"	HQS-822-00	HQS-822-10
.018" x .025"	HQS-825-00	HQS-825-10
.019" x .025"	HQS-925-00	HQS-925-10
.021" x .025"	HQS-225-00	HQS-225-10

FULL (Pk 100 Round / Pk 10 Rect.)		
Size	Upper	Lower
.012"	HQS-012-01	HQS-012-11
.014"	HQS-014-01	HQS-014-11
.016"	HQS-016-01	HQS-016-11
.018"	HQS-018-01	HQS-018-11
.020"	HQS-020-01	HQS-020-11
.016" x .016"	HQS-616-01	HQS-616-11
.016" x .022"	HQS-622-01	HQS-622-11
.017" x .022"	HQS-722-01	HQS-722-11
.017" x .025"	HQS-725-01	HQS-725-11
.018" x .018"	HQS-818-01	HQS-818-11
.018" x .022"	HQS-822-01	HQS-822-11
.018" x .025"	HQS-825-01	HQS-825-11
.019" x .025"	HQS-925-01	HQS-925-11
.021" x .025"	HQS-225-01	HQS-225-11

STANDARD (Pk 100 Round / Pk 10 Rect.)		
Size	Upper	Lower
.016"	HQS-016-05	HQS-016-15
.018"	HQS-018-05	HQS-018-15
.020"	HQS-020-05	HQS-020-15
.016" x .022"	HQS-622-05	HQS-622-15
.017" x .025"	HQS-725-05	HQS-725-15
.018" x .022"	HQS-822-05	HQS-822-15
.018" x .025"	HQS-825-05	HQS-825-15
.019" x .025"	HQS-925-05	HQS-925-15
.021" x .025"	HQS-225-05	HQS-225-15

Lingual Archwires

Mushroom and Universal archforms

A comprehensive range of high quality archwires specifically designed for the demands of lingual treatment.



Thermal Nickel Titanium

THERMAL NITI MUSHROOM			
Size	Pk 2	Upper	Lower
.016"	small	HQL-TN-016US	HQL-TN-016LS
	medium	HQL-TN-016UM	HQL-TN-016LM
	large	HQL-TN-016UL	HQL-TN-016LL
.016" x .022"	small	HQL-TN-1622US	HQL-TN-1622LS
	medium	HQL-TN-1622UM	HQL-TN-1622LM
	large	HQL-TN-1622UL	HQL-TN-1622LL
.017" x .017"	small	HQL-TN-1717US	HQL-TN-1717LS
	medium	HQL-TN-1717UM	HQL-TN-1717LM
	large	HQL-TN-1717UL	HQL-TN-1717LL
.017" x .025"	small	HQL-TN-1725US	HQL-TN-1725LS
	medium	HQL-TN-1725UM	HQL-TN-1725LM
	large	HQL-TN-1725UL	HQL-TN-1725LL

Nickel Titanium

NITI MUSHROOM			
Size	Pk 2	Upper	Lower
.010"	small	HQL-N-010US	HQL-N-010LS
	medium	HQL-N-010UM	HQL-N-010LM
	large	HQL-N-010UL	HQL-N-010LL
.013"	small	HQL-N-013US	HQL-N-013LS
	medium	HQL-N-013UM	HQL-N-013LM
	large	HQL-N-013UL	HQL-N-013LL
.016"	small	HQL-N-016US	HQL-N-016LS
	medium	HQL-N-016UM	HQL-N-016LM
	large	HQL-N-016UL	HQL-N-016LL

Stainless Steel Posted Wires

High quality brass posted wires with the strongest solder joints in the industry. Provides excellent results during the retraction and closing of spaces as well as giving added benefits such as attaching headgear, elastics and springs. The small solder spot on the wire allows for easier archwire engagement without bracket impingement.

- Highest quality stainless steel
- Strong solder joints
- Consistent quality
- Ideal post length - 5mm
- Supplied in a unique protective box



EURO (Pk 10)			
Size	.016" x .022"	.018" x .025"	.019" x .025"
22mm	HQP-1622-22E	HQP-1825-22E	HQP-1925-22E
24mm	HQP-1622-24E	HQP-1825-24E	HQP-1925-24E
26mm	HQP-1622-26E	HQP-1825-26E	HQP-1925-26E
28mm	HQP-1622-28E	HQP-1825-28E	HQP-1925-28E
30mm	HQP-1622-30E	HQP-1825-30E	HQP-1925-30E
32mm	HQP-1622-32E	HQP-1825-32E	HQP-1925-32E
34mm	HQP-1622-34E	HQP-1825-34E	HQP-1925-34E
36mm	HQP-1622-36E	HQP-1825-36E	HQP-1925-36E
38mm	HQP-1622-38E	HQP-1825-38E	HQP-1925-38E
40mm	HQP-1622-40E	HQP-1825-40E	HQP-1925-40E

FULL (Pk 10)			
Size	.016" x .022"	.018" x .025"	.019" x .025"
22mm	HQP-1622-22F	HQP-1825-22F	HQP-1925-22F
24mm	HQP-1622-24F	HQP-1825-24F	HQP-1925-24F
26mm	HQP-1622-26F	HQP-1825-26F	HQP-1925-26F
28mm	HQP-1622-28F	HQP-1825-28F	HQP-1925-28F
30mm	HQP-1622-30F	HQP-1825-30F	HQP-1925-30F
32mm	HQP-1622-32F	HQP-1825-32F	HQP-1925-32F
34mm	HQP-1622-34F	HQP-1825-34F	HQP-1925-34F
36mm	HQP-1622-36F	HQP-1825-36F	HQP-1925-36F
38mm	HQP-1622-38F	HQP-1825-38F	HQP-1925-38F
40mm	HQP-1622-40F	HQP-1825-40F	HQP-1925-40F

Stainless Steel

Available in universal lingual arch form in round and rectangular sizes

STAINLESS STEEL UNIV. (Pk 5)	
Size	U/L
.014"	HQL-SS-014
.016"	HQL-SS-016
.018"	HQL-SS-018
.016" x .022"	HQL-SS-1622

Beta Titanium

Universal lingual arch form

BETA TITANIUM UNIV. (Pk 5)	
Size	U/L
.016"	HQL-B-016
.016" x .022"	HQL-B-1622
.0175" x .0175"	HQL-B-175175

Nickel Titanium

Universal lingual arch form

NICKEL TITANIUM UNIV. (Pk 5)	
Size	U/L
.012"	HQL-NT-012
.014"	HQL-NT-014
.016"	HQL-NT-016

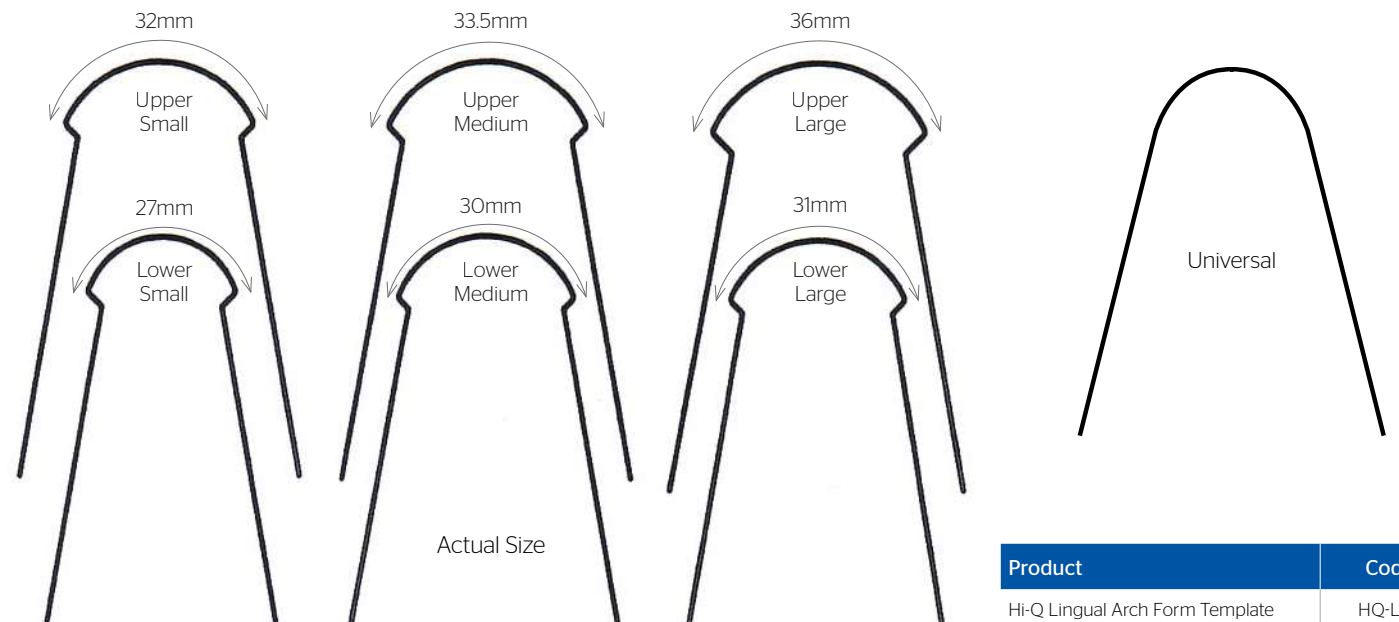

Product	Code
Hi-Q Lingual Arch Form Template	HQ-LAT

Essentials™

Value archwires

- Consistent quality guaranteed
- Euro arch shape
- Superb value for money!



Nickel Titanium

Super Elastic Nickel Titanium archwires with an extra smooth finish which reduces friction. Provides efficient treatment with gentle and consistent forces.

Size (Pk 10)	Upper	Lower
.012"	HEN-012-00	HEN-012-10
.014"	HEN-014-00	HEN-014-10
.016"	HEN-016-00	HEN-016-10
.018"	HEN-018-00	HEN-018-10
.020"	HEN-020-00	HEN-020-10
.016" x .022"	HEN-622-00	HEN-622-10
.017" x .025"	HEN-725-00	HEN-725-10
.018" x .025"	HEN-825-00	HEN-825-10
.019" x .025"	HEN-925-00	HEN-925-10
.020"x.020"	HEN-220-00	HEN-220-10

Thermal Nickel Titanium

Heat activated archwires with great shape memory characteristics. Soft and pliable at room temperature, they deliver gentle forces for maximum patient comfort and efficient tooth movement.

Size (Pk 10)	Upper	Lower
.012"	HE-012-00	HE-012-10
.014"	HE-014-00	HE-014-10
.016"	HE-016-00	HE-016-10
.018"	HE-018-00	HE-018-10
.016" x .022"	HE-622-00	HE-622-10
.017" x .025"	HE-725-00	HE-725-10
.018" x .025"	HE-825-00	HE-825-10
.019" x .025"	HE-925-00	HE-925-10
.020"x.020"	HE-220-00	HE-220-10

Stainless Steel

- Bright finish for reduced friction
- Outstanding value

Size (Pk 10)	Upper	Lower
.012"	HES-012-00	HES-012-10
.014"	HES-014-00	HES-014-10
.016"	HES-016-00	HES-016-10
.018"	HES-018-00	HES-018-10
.020"	HES-020-00	HES-020-10
.016" x .016"	HES-616-00	HES-616-10
.016" x .022"	HES-622-00	HES-622-10
.016" x .025"	HES-625-00	HES-625-10
.017" x .025"	HES-725-00	HES-725-10
.018" x .022"	HES-822-00	HES-822-10
.018" x .025"	HES-825-00	HES-825-10
.019" x .025"	HES-925-00	HES-925-10
.021"x.025"	HES-225-00	HES-225-10

NiTi Closed Coil Springs



- Provides constant force levels for efficient treatment
- Stays active until the space is closed
- Light, gentle forces helps patient comfort
- High quality superelastic NiTi

Closed Coil Springs	Force	Code
.009" x .030" 9mm (Pk 10)	100gm	GC-100-09
.009" x .030" 12mm (Pk 10)	100gm	GC-100-12
.011" x .030" 9mm (Pk 10)	150gm	GC-150-09
.011" x .030" 12mm (Pk 10)	150gm	GC-150-12
.012" x .030" 9mm (Pk 10)	200gm	GC-200-09
.012" x .030" 12mm (Pk 10)	200gm	GC-200-12
21" Spool .030" diameter	-	GC-030-21

NiTi Open Coil Springs

- For the opening or holding of spaces
- Provides consistent, gentle force levels
- High quality superelastic NiTi



Open Coil Springs	Length	Code
.010" x .030" (Pk 3)	7"	GC-030-07
.012" x .030" (Pk 3)	7"	GC-230-07
.014" x .030" (Pk 3)	7"	GC-336-07
.010" x .030" 15" Spool	15"	GC-030-15
.012" x .030" 15" Spool	15"	GC-230-21

NiTi Distalizing Springs

These stop wound springs distalize molars without having to use headgear. The springs are designed to be easily trimmed to the desired length; just determine the appropriate length and trim the spring in the middle of the closed coil section.

You can then place the spring over the archwire and when used in conjunction with an adjustable archwire lock or stop hook, provide the required force for your unique application.



7" Lengths (Pk 3)	Code
.010" x .045"	GD-145-07

Value NiTi Closed Coil Springs

- Close spaces easily for efficient, predictable tooth movement and great patient comfort.
- Strong eyelets easily attached to bracket hooks.



.010" x .030 (Pk 10)	Code
9mm	TOC-9MM
12mm	TOC-12MM

Value NiTi Open Coil Springs

Provides a gentle constant force for opening or holding spaces between teeth.

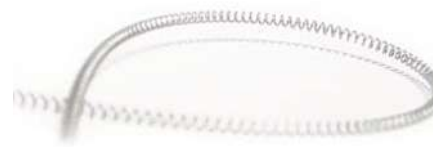

.010" x .030 (Pk 2)	Code
7" length	TOC-OCS

Stainless Steel Coil Springs

Open or Closed wound stainless steel wire designed to hold spaces.



3' Spool	Code
.010" x .030" Closed	GC-030-10
.010" x .030" Open	GC-030-00
.010" x .036" Open	GC-036-00

Coated NiTi Open Coil Springs

Coated for superior aesthetics with a consistent force level.



7" Lengths (Pk 3)	Code
.012" x .030" (.014" x .027" coated)	GC-030-60

Preformed Ligature Ties

- High quality polished stainless steel
- Consistently shaped for a perfect fit under the tie-wing



Size (Pk 1000)	Code
.009"	GL-009-00
.010"	GL-010-00
.012"	GL-012-00

Preformed Shorty Ligature Ties

- High quality polished stainless steel
- Quick and easy engagement



Size (Pk 500)	Code
.010"	GL-010-50

Kobayashi Ties

- High quality polished stainless steel
- Quick placement of auxiliary hook on brackets



Size (Pk 100)	Code
.012"	GK-012-00

Kobayashi Shorty Ties

- High quality polished stainless steel
- Quick and easy engagement

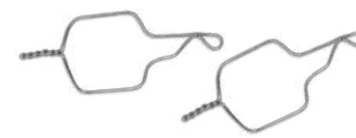

Size (Pk 100)	Code
.012"	GK-012-50
.014"	GK-014-50

Coated Preformed Ligature Ties

- Tooth coloured for great aesthetics
- Durable plastic coating
- Stainless steel



Size (Pk 100)	Code
.010" (.012" coated)	GL-012-60

Coated Preformed Shorty Ties

- Tooth coloured - blends well with aesthetic brackets
- Durable plastic coating
- Stainless steel

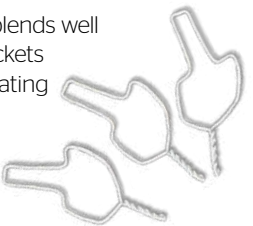

Size (Pk 100)	Code
.010" (.012" coated)	GL-012-61

Coated Kobayashi Shorty Ties

- Tooth coloured for great aesthetics
- Durable plastic coating
- Stainless steel



Size (Pk 100)	Code
.012" (.014" coated)	GK-014-60

Co-Axial Wire

High quality 6-strand coaxial wire available in 30' spool or 14" lengths.



Size	Code
.0175" / 14" Length (Pk 10)	GS-175-14
.0155" / 30' Spool	GS-155-30

Crimp-It™

Diamond coated crimpable stop/tie back

A new crimpable stop that will not slide and can also be used as a tie back.

The slot feature in the Crimp-It is faster and easier to use than creating a tie back loop in the archwire or soldering a tie back hook to the archwire. The proprietary diamond coating provides exceptional holding force; more than double that of uncoated crimpable stops.

The Crimp-It is easy to place without any special instrument and crimps without damaging or notching the archwire with no need to over-crimp due to the diamond coating.

Fits wire sizes .012" up to .012" x .025".



Code (Pk 10)
JS-125-00

Ceramic Buttons & Hooks

For a clear look with all aesthetic appliances

- For labial and lingual use
- Mesh base creates a strong bond
- Anatomy and size of base fits all teeth
- Maintains a clear look for aligners as anchorage for elastics



Product (Pk 10)	Code
Bondable Ceramic Button	JB-334-00
Bondable Ceramic Hook	JB-335-00

Precision Aligner Buttons

A button designed specifically for aligners!

- Base shaped to fit precisely within aligner cut outs
- Maximum retention through optimal surface area and unique bonding base
- Anatomically corrects to match the curvature of molar's cervical third
- Smooth rounded contours for improved patient comfort
- Improve Aligner and Class II efficiency
- Reduce emergency visits

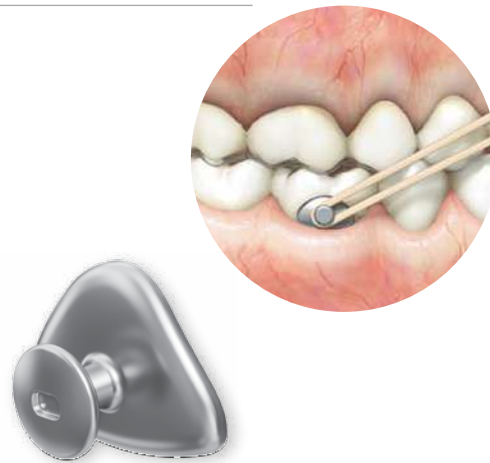

Code (Pk 25)
JB-336-00

Bondable Buttons Round Base

- One piece
- Round curved base



Code (Pk 10)
JB-400-02

Bondable Buttons Rectangle Base

- Rectangular curved base
- One piece base



Code (Pk 10)
JB-400-00

Bondable Composite Buttons

- Aesthetic and stain resistant
- Contoured mechanical base for optimal bonding
- Ideal for use with aligners



Code (Pk 10)
JB-234-00

Bondable Composite Eyelets

- Aesthetic and stain resistant
- Contoured mechanical base for optimal bonding
- Funnelled entry for easy wire insertion



Code (Pk 10)
JB-235-00

Bondable Eyelets Round Base

- Two piece flat base
- Round base



Code (Pk 10)
JE-025-10

Bondable Eyelets Rectangle Base

- One piece
- Rectangular curved base



Code (Pk 10)
JE-025-00

Crimpable Ball Hooks

- With slide-on archwire opening
- .018" and .022" options available



Size (Pk 10)	Code
.018"	JH-018-10
.022"	JH-022-10

Crimpable Archwire Hooks

- With split archwire opening
- Easy to place without removing the archwire
- Also ideal for use with TADs and mini-screw attachments
- Fits archwires up to .022" x .025"



Right hook (Pk 20)	Left hook (Pk 20)
JH-101-00	JH-101-01

Crimpable Ball Hooks

- Place easily without removing the archwire
- Made from high quality stainless steel
- Smooth, rounded hook for patient comfort
- Fits archwires up to .022" x .025"



Code (Pk 20)
JH-121-01

Crimpable Bi-Directional Ball Hooks

- Place easily without removing the archwire
- Bi-directional hook for easy ligation
- Smooth, rounded hook for patient comfort
- Fits archwires up to .022 x .025"



Product (Pk 20)	Code
Short (1.6mm)	JH-111-01

Coated Crimpable Bi-Directional Ball Hooks

- Great aesthetics
- Non-sliding, strong lock with archwire
- Ball hook can be bent left or right
- Fits round or rectangular archwire up to .018" x .025"
- 4mm length



Code (Pk 10)
JH-907-00

Crimpable Mini Stops

- Mini-size stops with very low profile
- 2mm length
- High quality stainless steel



Product (Pk 25)	Code
Small (for wire sizes .012" to .018")	JS-020-01
Large (for wires .014"x.025" to .019"x.025" & square .020"x.020")	JS-020-02

Coated Crimpable Mini Stops

- For a complete aesthetic look
- Slides easily on to the archwire
- Great comfort for the patient
- 2mm in length



Product (Pk 25)	Code
Small (for round wires)	JS-907-01
Large (for square and rectangular wires)	JS-907-02

Mighty Ties™

Great value elastomerics

.115" ligature diameter, with 30 great colours for your patients to choose from!

- 1008 ties per pack (24 per stick)
- Superior elasticity with great recovery
- Excellent colour stability, resistant to fading
- Convenient tabs makes them easy to grip
- High quality medical grade polyurethane
- Latex free minimises allergic reactions



MADE IN USA

ALL LATEX FREE!

Mighty Ties™ Mini

With all the same features of Mighty Ties these single patient ties reduce waste and cross contamination.

- 1000 ties per pack (10 ligatures per stick)

Colour	MightyTies™ (Pk 1008)	MightyTies™ Mini (Pk 1000)
Assorted Colours	EL-120-00	-
Grey	EL-120-01	EM-120-01
Clear	EL-120-02	EM-120-02
Tooth	EL-120-03	EM-120-03
Royal Blue	EL-120-04	EM-120-04
Baby Blue	EL-120-05	EM-120-05
Purple	EL-120-06	EM-120-06
Periwinkle	EL-120-07	EM-120-07
Red	EL-120-08	EM-120-08
Magenta	EL-120-09	EM-120-09
Black	EL-120-10	EM-120-10
White	EL-120-11	EM-120-11
Yellow	EL-120-12	EM-120-12
Baby Pink	EL-120-13	EM-120-13
Aqua	EL-120-14	EM-120-14
Neon Green	EL-120-15	EM-120-15
Kelly Green	EL-120-16	EM-120-16
Emerald	EL-120-17	EM-120-17
Orange	EL-120-18	EM-120-18
Teal	EL-120-19	EM-120-19
Metallic Silver	EL-120-20	EM-120-20
Marigold	EL-120-21	EM-120-21
Fuschia	EL-120-26	EM-120-26
Turquoise	EL-120-27	EM-120-27
Lilac	EL-120-29	EM-120-29
Midnight Blue	EL-120-30	EM-120-30
Sparkle Blue	EL-120-33	EM-120-33
Glow in the Dark	EL-120-50	EM-120-50
Neon Plnk	EL-120-60	EM-120-60
Pearl	EL-120-71	EM-120-71
Carolina Blue	EL-120-72	EM-120-72

Mighty Ties™ Keyring

A handy keyring for easy selection of Mighty Ties colours



Mighty Ties™	Code
Colour Chart	EL-000-00
Sample keyring (30 sticks)	EL-000-10

Mighty Links

- Great for closing intra-arch space
- Super for rotating individual teeth
- Provides continuous gentle force
- More hygienic than chain - less opportunity for food to accumulate
- Grey or clear - your choice
- Handy assorted pack - contains all sizes

COMPARE TO E-LINKS™ FROM TP ORTHO



Pk 100	4.3mm	6.0mm	8.5mm	11.5mm	Assorted
Dark Grey	EE-043-00	EE-060-00	EE-085-00	EE-115-00	EE-000-00
Clear	EE-043-10	EE-060-10	EE-085-10	EE-115-10	EE-000-10

Mighty Chain™

Great value chain

- Superior elasticity with great recovery
- Excellent colour stability, resistant to fading
- High quality medical grade polyurethane
- Latex free minimises allergic reactions

Colour (15' Spool)	Closed	Short	Long
Grey	EC-130-01	EC-140-01	EC-150-01
Clear	EC-130-02	EC-140-02	EC-150-02
Tooth	EC-130-03	EC-140-03	EC-150-03
Metallic Silver	EC-130-04	EC-140-04	EC-150-04
Turquoise	EC-130-05	EC-140-05	EC-150-05
Sparkle Blue	EC-130-06	EC-140-06	EC-150-06
Neon Pink	EC-130-07	EC-140-07	EC-150-07
Royal Blue	EC-130-08	EC-140-08	EC-150-08
Red	EC-130-09	EC-140-09	EC-150-09



Mighty Ties™ Micro

For use with lingual or mini brackets these have a reduced diameter of 0.095"



.095" (Pk 1008)	Closed
Silver	EM-095-20

Elast-o-Loop™ Separators

- Smooth injection moulded plastic
- Radiopaque and Non-radiopaque
- Latex free



Product (Pk 960)	Code
Blue	ES-300-01
Radiopaque - blue	ES-300-06

Elast-o-Loop™ Tab Separators

- Lingual and labial tabs to prevent sub-gingival loss
- Easier to remove than other types of separator
- Stronger rebound and memory than radiopaque separators
- Latex free



Product (Pk 960)	Code
Purple	ES-300-00

Loose Separators

- Smooth injection moulded plastic
- Radiopaque
- Latex free



Colour	Code
Blue (Posterior - Pk 1000)	ES-300-02
Green (Anterior - Pk 100)	ES-300-05

Rotation Wedges

- Modules fit closely over the bracket tie-wings and stay securely in place
- Wedge shape handle for easy identification and dispensing
- Latex free



Colour (Pk 100)	Code
Grey	EW-300-03
Clear	EW-300-04

Bumper Sleeve

Latex free, stain resistant sleeve for archwires

10' Spool	Code
.018" Grey	EB-018-00
.018" Clear	EB-018-01
.027" Grey	EB-027-00
.027" Clear	EB-027-01

Elastic Thread

- Excellent stretch and rebound
- Solid and hollow options available



Size	Solid	Hollow
.020" Grey	ET-020-01	-
.020" Clear	ET-020-02	-
.025" Grey	ET-025-01	ET-025-11
.025" Clear	ET-025-02	ET-025-12
.030" Grey	ET-030-01	ET-030-11
.030" Clear	ET-030-02	ET-030-12

Extra-Oral Elastics

- High quality medical grade elastics for extra-oral use
- Provides consistent and accurate force levels

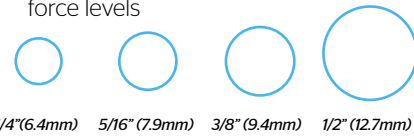

Size (Pk 1000)	Force	Code
1/4"	16oz	EX-160-14
5/16"	16oz	EX-160-51
3/8"	16oz	EX-160-38
1/2"	16oz	EX-160-12

Elastic Directors

- Helps your patients place and remove elastics more easily
- Multi-coloured pack



Code (Pk 100)

EP-100-00

Woodland Creatures™

Intra-oral elastics

- Manufactured using only Surgical Class I Grade natural latex
- Precision cut to force value
- Clean-cut edges ensure consistent expansion and force
- In-process testing provides consistent force values
- Patient friendly identification system
- Supplied in a box of 50 packs containing 100 elastics

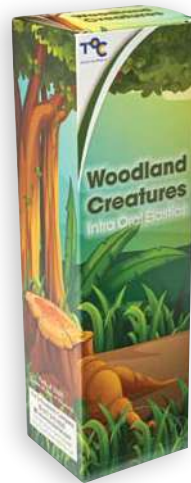

Actual size	○	○	○	○	○
Size	1/8" (3.2mm)	3/16" (4.8mm)	1/4" (6.4mm)	5/16" (7.9mm)	3/8" (9.5mm)
Force					
Light 2.5oz (71g)	Ant	Beetle	Snail	Butterfly	Frog
Natural Latex	EW-250-18	EW-250-31	EW-250-14	EW-250-51	EW-250-38
Medium 4.5oz (128g)	Bat	Warbler	Woodpecker	Owl	Hawk
Natural Latex	EW-450-18	EW-450-31	EW-450-14	EW-450-51	EW-450-38
Latex Free	-	EW-450-31LF	EW-450-14LF	-	-
Heavy 6.5oz (184g)	Mouse	Hedgehog	Fox	Badger	Deer
Natural Latex	EW-650-18	EW-650-31	EW-650-14	EW-650-51	EW-650-38
Latex Free	-	EW-650-31LF	EW-650-14LF	-	-

TruGrip®

Reliable and consistent bonding

Light Cure Bracket Adhesive Kit

Tru-Grip gives you state-of-the-art technology so you have versatility, ease of handling, aesthetics and reliability at your finger tips. With the ability to bond ceramic, composite and metal brackets and with no bracket drift because of the ideal viscosity, Tru-Grip LC has everything you need in an adhesive. It offers a simple and comfortable application procedure combined with extremely reliable bond strength. Tru-Grip LC provides extended working time to ensure accurate bracket placement and is also a great choice for lingual bonding.

- No mixing required
- Light cure in only 30 seconds
- Ideal viscosity
- Precise placement
- Reliable bond strength



Product	Code
Light Cure Bracket Adhesive Kit	TG-100-00
Light Cure Bracket Adhesive Trial Kit	TG-100-10
Light Cure Syringe Bracket Adhesive Paste, 5gm	TG-100-20
Light Cure Adhesive Primer, 16ml	TG-100-30

Kit Includes:

15ml Liquid Etch, 7gm Primer, 4 x 5gm Paste Syringes, Spatulas, Mixing Pads, Brush Holder, Brushes

Trial Kit Includes:

6gm Liquid Etch, 3ml Primer, 1 x 5gm Paste Syringe, Spatulas, Long Handle Brushes

TOC Intra-Oral Elastics

TOC's Flower Elastics are manufactured from the finest surgical grade natural latex and latex free rubber to ensure reliable force delivery.

- Colour coded bags for easy identification
- Fresh and uncontaminated due to air-tight seal
- Patient bag includes 100 lightly powdered elastics for easy use with no residue
- 20 patient packs, each containing 100 elastics



All trademarks belong to their respective owners

Product (Pk 20)	Colour	Force	Size	Latex	Latex-free
Daffodil	Yellow	2oz	5/16"	E20-516	-
Rose	Red	3.5oz	3/16"	E35-316	E35-316LF
Iris	Blue	3.5oz	1/4"	E35-14	E35-14LF
Mint	Green	3.5oz	5/16"	E35-516	-
Fuschia	Pink	3.5oz	3/8"	E35-38	-
Marigold	Orange	4.5oz	1/4"	E45-14	E45-14LF
Thistle	Grey	4.5oz	3/16"	E45-316	-
Honeysuckle	Tan	4.5oz	5/16"	E45-516	-
Heather	Mauve	6oz	5/16"	E60-516	-

TruGrip® Light Cure Band Cement

Tru-Grip Light Cure Orthodontic Band Cement requires no mixing and provides all the working time you want together with consistent performance. Acid etching isn't necessary and curing is possible in 20 seconds with a high performance curing light. The syringe gives easy and accurate delivery of the cement reducing waste and the distinctive blue colour makes for easy clean up.

- Acid etching not necessary
- No-mixing so less waste
- Cures on demand
- High bond strength
- Contains fluoride



Product	Code
Light Cure Band Cement Kit, 6 x 5gm syringes	TG-400-00
Light Cure Band Cement syringe	TG-400-20

Bulk Gel Etch Kit

Phosphoric Acid Gel in a luer lock syringe. Green colour for visual confirmation of application and rinsing. Luer lock tips are angled for easy access and better control.



Product	Code
Gel Etch Kit	BULKETCH
Etch Tips (Pk 100)	TOCFBG270

Kit Includes:
60g Gel Etch,
5 empty 3ml Syringes,
Luer Lock Applicator
Tips

Blue Gel Etch



12g syringe of 37% phosphoric acid gel in bright blue, which makes it easy to see for application and rinsing. Luer lock tips are angled for easy access and better control.



12g Syringe with 20 Applicator Tips (Luer Lock)

Code
TG-000-30

Liquid Etch

A thin consistency etch used to make enamel and dentin susceptible to bonding. It conditions the tooth to enhance adhesion and mechanical retention.

- 37% Phosphoric acid
- Green colour
- Viscosity similar to water
- 30ml (1fl oz) per bottle



Code
506107

Adhesive Primer Light Cure

Prepares etched enamel ready for bonding.

- Easy to use
- Trusted reliability
- For use with metal, plastic and ceramic brackets
- Ensures consistent bond strength



Product	Code
Adhesive Primer Light Cure, 7gm	TG-100-30

Porcelain Primer

For preparing porcelain crowns and veneers before bonding brackets.

Used in addition to orthodontic adhesive primers.



Product	Code
Porcelain Primer, 15ml	TOCPP

Double Ended Photo Cheek Retractors



- Brushed stainless steel to reduce glare
- Double-ended with a different size on each end for adult and child
- Longer lasting compared to plastic retractors

Sterilisable up to 320°F/160°C

Product (Pk 2)	Code
Brushed Stainless Steel	LR-159-00

Double Ended Photo Cheek Retractors



- Sturdy plastic will not crack
- Double ended for adult and child sizes
- Smooth with rounded edges for patient comfort

Autoclavable up to 250°F/121°C

Code (Pk 2)
LR-155-00

Double Ended Photo Cheek Retractors



- Smooth comfortable edges
- Double-ended with a different size on each end for adult and child

Product (Pk 2)	Code
Autoclavable (up to 270°F/132°C)	QC-400-01

Product (Pk 2)	Code
Heat Sterilisable (up to 370°F/188°C)	QC-400-02

Retract-EEZ® Photo Lip Retractor

- Allows unrestricted access
- Perfect for occlusal photographs and quick direct bond repair
- Extremely comfortable for patients
- Angled head retracts lips
- One size fits most



Code (Each)
QL-500-01

Extraoral Cheek Retractors

- Provides a full view and easy access for bonding
- Cold Sterilisable



Product (Pk 2)	Code
Child	LC-300-20
Teen	LC-300-21
Adult	LC-300-22

Soft-Dex Cheek Retractors

Soft and pliable, these retractors are easy to place and ideal for patient comfort. Provides a full view of the anterior and posterior regions.



Adult and Child sizes available

Product (Pk 2)
LC-500-01 / LC-500-02

Long-Handled Photo Cheek Retractors

- Strong, clear plastic
- Comfortable with smooth edges
- Adult and child sizes



Product (Pk 2)	Code
Small	QC-300-01
Large	QC-300-02

Autoclavable up to 270°F/132°C

Extraoral Cheek Retractors

- Provides a full view and easy access for bonding
- Strong one piece design



Product	Code
Child	LC-100-01
Adult	LC-100-02

Sterilisable up to 370°F/188°C

Lip Ring Retractor

- Great for bonding and intraoral photography
- Can also be used to protect lips during interproximal stripping
- Made of high quality medical grade plastic
- Cold Sterilisable



Code (Pk 2)
LR-400-02

Intraoral Cheek Retractors

- Allows maximum access to the whole mouth
- Disposable and autoclavable options



Autoclavable	Code	Disposable (Pk 10)	Code
Child	LC-300-01	Child (Green)	LC-200-01
Teen	LC-300-02	Teen (Blue)	LC-200-02
Adult	LC-300-03	Adult (Red)	LC-200-03

High Heat Cheek Retractor

Easy to use, this High Heat Cheek Retractor provides superior intraoral access for bonding and other procedures. The unique buccal extensions retract powerful buccinator muscles to provide an unobstructed view. Made from medical grade materials that withstand repeated sterilisation. One size fits all.

- Provides an unobstructed view with superior buccal access
- Comfortable for the patient
- Easy tension control
- Increased visibility to work areas



Product	Code
High Heat	LC-400-01

Autoclavable and dry heat sterilisable up to 350°F/177°C

Replicate™

Chromatic alginate for high precision impressions

- Designed for orthodontics and high precision dentistry
- High accuracy to 20 microns for finer detail
- Colour changing - purple for mixing, pink to load the impression tray and yellow for insertion into the mouth
- Extra fast setting time in the mouth - with a minimum of only 30 seconds
- High elasticity and resistance to tear
- High dimensional stability - over 100 hrs
- Easy to mix and dust free

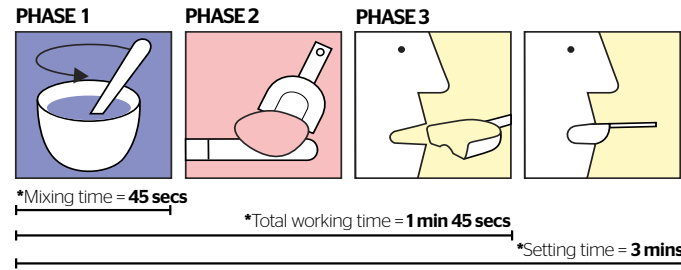

Product	Code
Bag - 450g	RR-450-00
Starter Kit (2x450g, measures, container)	RR-450-10
Measure Set	RR-100-00
Storage Container	RR-200-00

TOC Impression Trays

Perfect impressions first time

- Excellent rigidity with no distortion when seating or removing tray
- Superior alginate retention for a clean complete impression
- No tray adhesive required

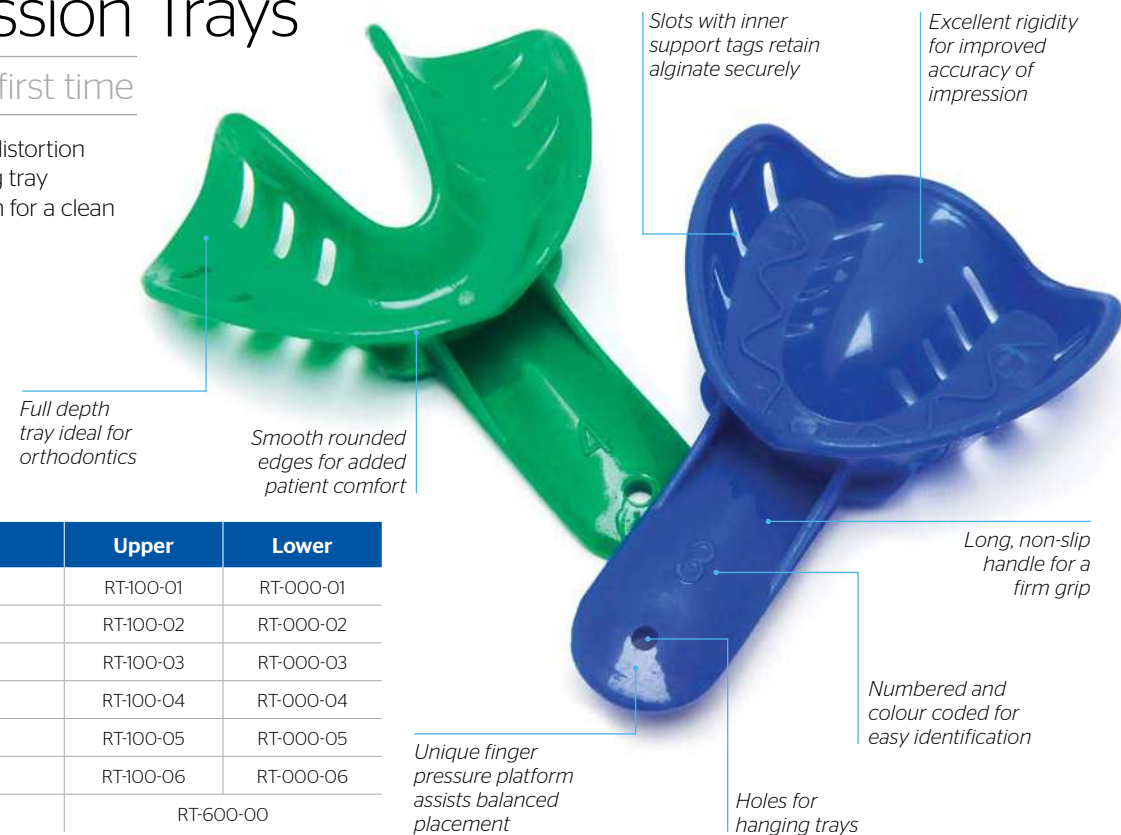

Size (Pk 50)	Upper	Lower
1 - Red (Pedo)	RT-100-01	RT-000-01
2 - Orange (Extra Small)	RT-100-02	RT-000-02
3 - Blue (Small)	RT-100-03	RT-000-03
4 - Green (Medium)	RT-100-04	RT-000-04
5 - Yellow (Large)	RT-100-05	RT-000-05
6 - Purple (Extra Large)	RT-100-06	RT-000-06
Mixed Bag (Pk 40 U/L Sizes 2-5)	RT-600-00	

TruPix™ Rhodium Coated Glass Mirrors

Superior reflectivity to chrome and metal mirrors

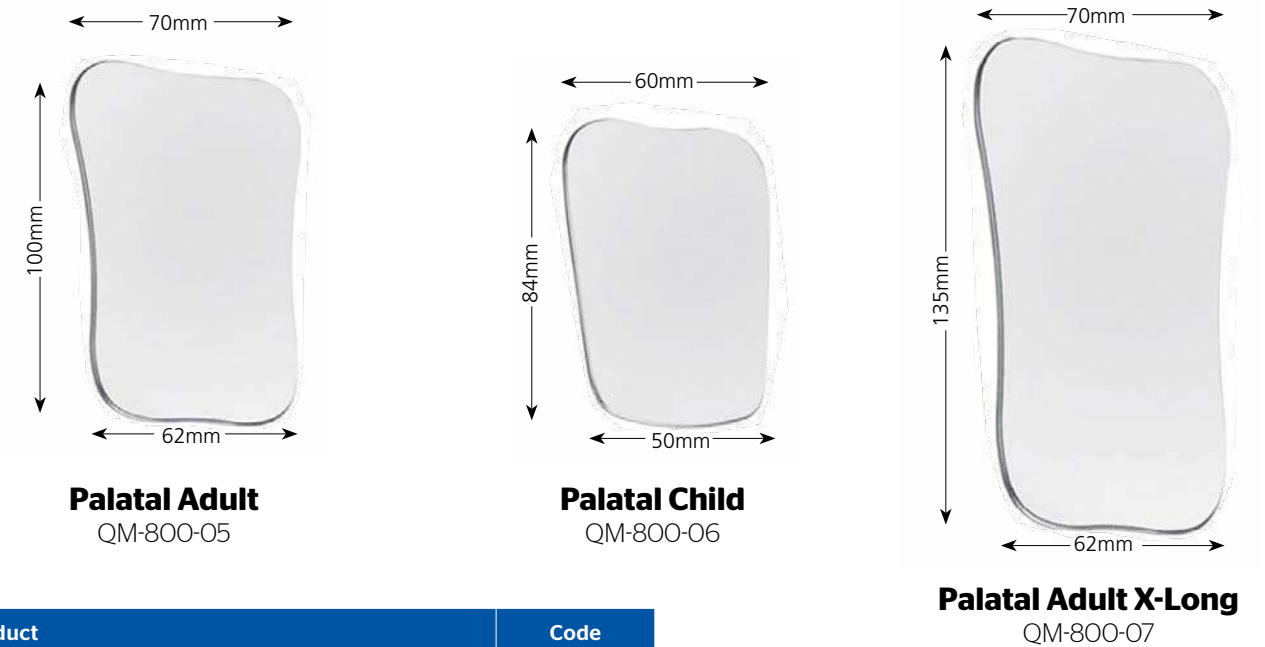
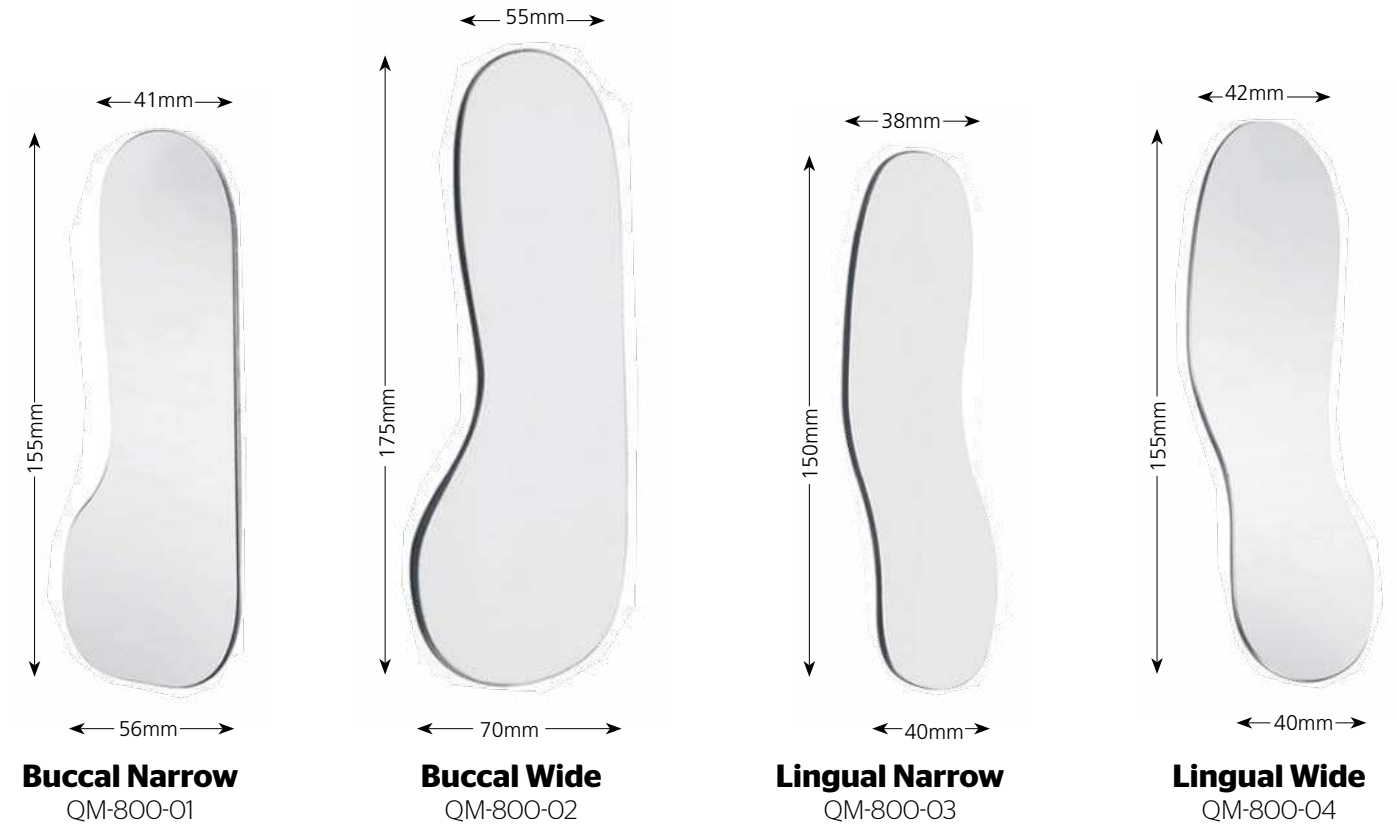

Product	Code
Buccal Narrow - 155mm x 56mm	QM-800-01
Buccal Wide - 175mm x 70mm	QM-800-02
Lingual Narrow - 150mm x 40mm	QM-800-03
Lingual Wide - 155mm x 42mm	QM-800-04
Palatal Adult - 100mm x 70mm	QM-800-05
Palatal Child - 84mm x 60mm	QM-800-06
Palatal Adult X-Long - 135mm x 70mm	QM-800-07

- High quality for the best photography results
- Superior reflectivity to chrome and metal
- Double-sided
- Incredibly smooth edges
- Autoclavable

Pure Plastics™

Quick - Easy - Affordable

Pure Plastics is a comprehensive range of thermoforming materials and accessories of the highest quality. Pure Plastics are CE marked, fully biocompatible, and provide exceptional performance at affordable prices.

Diamond™

Whitening Tray Material

- Easy to work with
- Exceptional performance



Product (Pk 25)	Code
1mm / .040" Circle	D-40-125R
1mm / .040" Square	D-40-127S
1.5mm / .060" Circle	D-60-120R
1.5mm / .060" Circle	D-60-125R
1.5mm / .060" Square	D-60-133S
2mm / .080" Square	D-80-133S

Crystal™

Clear Retainer Material

Offers excellent clarity and is the preferred option when acrylic needs to be incorporated into the appliance.

- Almost invisible in the mouth
- Excellent rigidity - ideal for tooth movement
- Accepts bonding agents
- May also be used for retainers
- Perfect for creating bite planes and TMJ splints



Product	Pack Size	Code
0.75mm / .030" Circle - 120mm	30	C-30-120C
0.75mm / .030" Circle - 125mm	30	C-30-125C
0.75mm / .030" Square	30	C-30-127S
1mm / .040" Circle - 120mm	50	C-40-120C
1mm / .040" Circle - 125mm	50	C-40-125C
1mm / .040" Square	50	C-40-127S
1.5mm / .060" Square	45	C-60-127S



Opal™

Durable Retainer Material

Provides durability and strength making it the first choice for retainers.

- Natural looking
- Tough - ideal for retainers
- May also be used for tooth moving appliances
- Abrasion resistant - ideal for patients who brux



Product (Pk 50)	Code
1mm / .040" Circle - 120mm	O-40-120C
1mm / .040" Circle - 125mm	O-40-125C
1mm / .040" Square	O-40-127S



Ice™

Retainer Material

Offers a great combination of strength and clarity for a superior invisible appliance.

- Forms clear for great aesthetics
- Perfect for invisible retainers, minor tooth movement and temporary bridges
- Superb thermoforming properties

Product (Pk 20)	Code
0.75mm / .030" Square	I-30-127S
0.75mm / .030" Circle	I-30-125C
1mm / .040" Circle	I-40-120C
1mm / .040" Circle	I-40-125C
1mm / .040" Square	I-40-127S
1.5mm / .060" Square	I-60-127S



All trademarks belong to their respective owners



Interproximal Diamond Strips

Perforated and flexible

- Perfect for interproximal reduction, recontouring and finishing contact points
- Single sided
- Autoclavable
- 2 widths: Narrow (2.5mm) and Wide (3.75mm)
- 4 grades: coarse, medium (45 micron), fine (30 micron), extra-fine (15 micron)

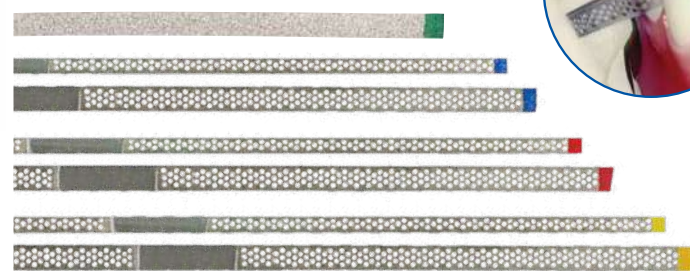

Interproximal Strips (Pk 10)	Narrow	Wide
Extra Fine (Yellow)	IS-600-03	IS-500-03
Fine (Red)	IS-600-02	IS-500-02
Medium (Blue)	IS-600-01	IS-500-01
Coarse (Green)	-	IS-700-00

Interproximal Strip Kit (Pk 15)	Code
Narrow kit (includes 5x Extra Fine, 5x Fine, 5x Medium)	IS-600-00
Wide kit (includes 5x Extra Fine, 5x Fine, 5x Medium)	IS-500-00

Lingual Debonding Burs

Egg shaped burs designed for lingual access adhesive removal. The smooth, safe-end non cutting tip prevents damage to the gingival surface.



Product (Pk 5)	Code
Right Angled	TOCH379-023RA
Friction Grip	TOCH379-023FG

Carbide Debonding Burs

- High precision burs for efficient finishing of composite, amalgam and enamel
- Corrosion resistant finish
- 12 Flute, friction grip



Heat sterilisable up to 340°F/170°C
Autoclavable up to 250°F/121°C

Product (Pk 5)	Code
Long Taper, High speed, 8mm head	IB-310-16
Long Flame, High speed, 8mm head	IB-310-12
Football, High speed, 4.4mm head	IB-310-23

Tungsten Carbide Debonding Burs

Quantum burs are designed, manufactured and finished for optimum strength, performance and durability offering efficient debonding and adhesive removal. They are brazed at the base of the neck as opposed to the base of the head as found in many competitor products. The stainless steel shanks allows for multiple autoclave cycles without the risk of corrosion and the convenient blister packaging keeps burs safe and well protected until needed.



Exceeds all ISO, FDA, BSI and CE European standards.

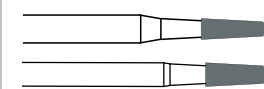

8 Flute	Right Angled (Slow)	Friction Grip (Fast)
.012" (Pk 10)	TOC1171RA	TOC1171FG
.016" (Pk 10)	TOC1172RA	TOC1172FG

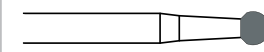

12 Flute	Right Angled (Slow)	Friction Grip (Fast)
.018" (Pk 5)	TOC7006RA	TOC7006FG

Tennis™ Instruments

A Collection of High Quality, Hand Crafted Instruments

Slim, Elegant, Beautiful

Tennis instruments - starts with a great design, the finest materials and a commitment to quality. Tennis instruments are meticulously handcrafted with up to 30 painstaking steps and multiple inspection points. Tennis combines aesthetic beauty, great durability and ease of use - perfect for the modern orthodontist.

High Quality European Stainless Steel

Tennis are carefully constructed from high quality European medical grade stainless steel to guard against corrosion and to ensure long life and superior performance. Every Tennis instrument is thoroughly tested and inspected so you can be assured of the highest quality at your fingertips.

Attractive Lustre Finish

Tennis features an attractive two tone design. The main body is satin finished to be non-reflective and reduce glare. The highly polished handle ends of labial instruments and black to lingual make for easy identification.

Dependable Orbit Joint

The smooth, durable orbit joint is one of the reasons you'll enjoy reliable performance. This joint protects against debris intrusion and promises dependable alignment of the tips to give you reliable cutting or wire forming.

User Friendly Ergonomic Design

Tennis provides safety and comfort for you and your patient. With their ideal size and smooth, rounded edges Tennis are safe in operation and a pleasure to use.

Cutters

Safety Hold Distal End Cutter

For safe intraoral use, shear cuts and securely holds wire from .012" to .021" x .025". Long handled version also available.

Code

TEN301

TEN301XL (Long)



Hard Wire Cutter

The go to wire cutter - Cuts hard wire from .022" x .028" and .028".

Code

TEN304



Mini Pin and Ligature Cutter

Cuts soft wire up to .012" with the slim tips making it easy to use in awkward areas.

Code

TEN306



Micro Mini Pin and Ligature Cutter

Extra slim cutter designed for even easier access in constricted areas, for soft wire up to .012".

Code

TEN307

TEN309 (15° angled)



Pin and Ligature Cutter

A standard non angulated pin cutter for use on soft wire from .012" to .016".

Code

TEN305

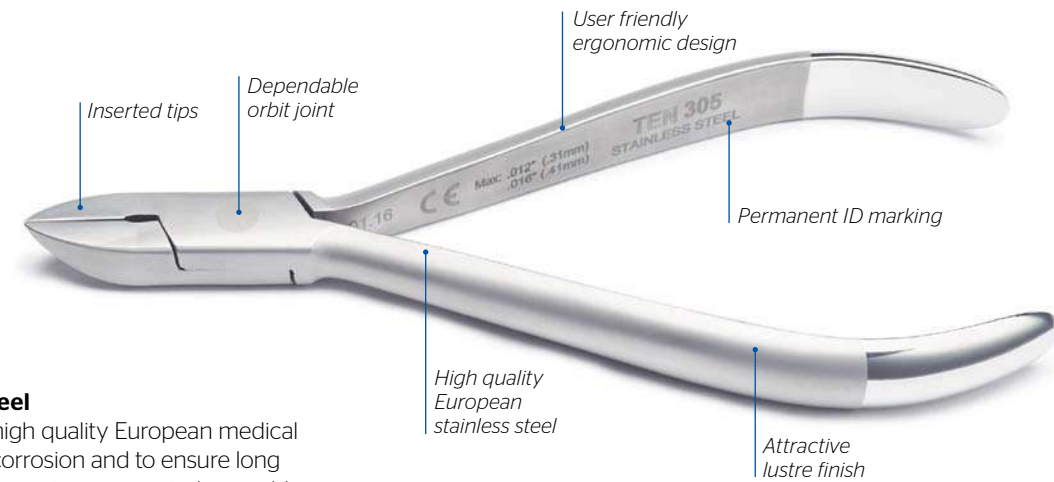

Permanent I.D. Marking

Tennis instruments are engraved with the recommended wire capacity to help you choose the right instrument for every procedure, every time.

Inserted Tips

Tennis cutters feature extra hard Resist Stainless Steel inserted tips. Resist undergoes several steps to achieve the ideal hardness necessary for reliably cutting orthodontic archwires.



Pliers

Weingart Plier

The serrated beaks grip archwires firmly and the angled tips fit easily into awkward areas. A general utility plier with many practical uses.

Code

TEN302 (Standard)

TEN303 (Slim)



Three Jaw Plier

For adjusting and contouring archwires, clasps and retainer wire up to .030" without damage. The tapered beaks allows for delicate bending.

Code

TEN312



Adhesive Removing Plier

Superior tip design allows easy access to remove excess adhesive after debonding.

Code

TEN316



Band Removing Plier

For the safe and quick removal of posterior bands. The pointed beak slips under the band while the plastic tip protects the occlusal surface of the tooth.

Code

TEN317



Rectangular Forming Arch Plier (Tweed)

Great for bending and torquing archwires with no damage. For archwires up to .022" x .025".

Code

TEN318



Bracket Remover - Straight

The sharp tips grip securely between the edge of bracket base and tooth surface, lifting off the bracket with no patient discomfort.

Code

TEN319



Bracket Remover - Angled

Similar to TEN319 but with angled beaks for easier access in difficult to reach posterior brackets.

Code

TEN320



Hammerhead NiTi Cinch Back Plier

Cinches and bends NiTi archwire intra-orally distal to the buccal tube with no heat necessary. For archwires up to .025".

Code

TEN327



Light Wire Plier

Has tapered beaks which allow intricate bends and loops to be made in archwires up to .020". The smooth un-grooved beaks make it ideal for bending light wires.

Code

TEN328



Hook Crimping Pliers

Easily and quickly crimp stops, hooks and posts to the archwire. Slot fits over base of hook while holding it tight for crimping.

Code

TEN329



Bird Beak Plier

A utility plier for all types of wire bending. The round and pyramid tapered tips work round, square and rectangular archwires up to .30".

Code

TEN330



OTHER TENNIS PLIERS AVAILABLE

How Utility Plier
Loop Forming Plier (Tweed)

Code

TEN333

TEN326

Tenvis™ Lingual Instruments

Handcrafted Instruments specifically for Lingual use



- Resist™ Stainless Steel cutting tips for reliability and superior cutting action
- Satin black handles for easy identification
- Satin finish to reduce glare
- Fine tips and long handles specifically designed for lingual use

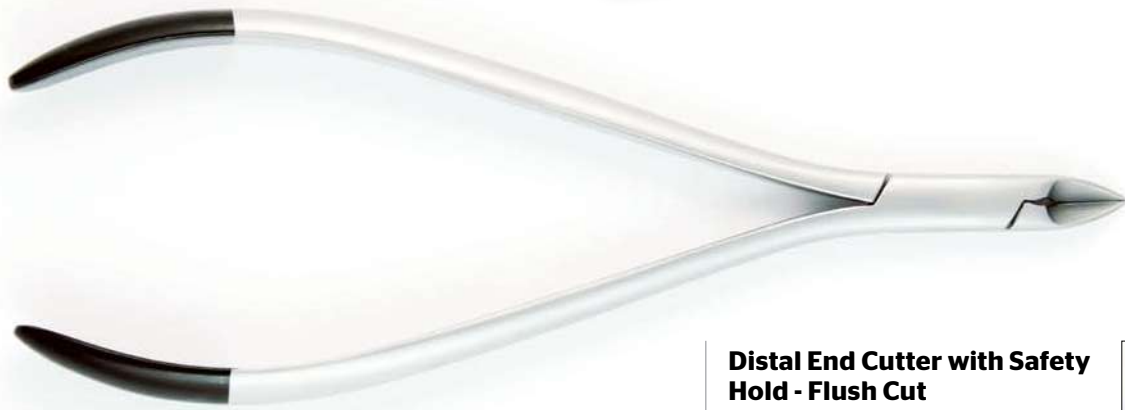

Weingart Pliers

Useful utility pliers with a 60° angle making them ideal for lingual use. Carefully finished slim beaks for confident use in confined areas.



Code

TEN377LG

Distal End Cutter with Safety Hold - Flush Cut

Bring an end to patient discomfort with this specially designed flush cut safety hold cutter. Cuts wire flush to end of buccal tube so no excess wire can impinge on soft tissue. Wire capacity .016" to .021" x .025".



Code

TEN323LG (wires .016" to .021" x .025")

TEN323BLG (wires .012" to .016" x .025")

Debonding Pliers

Fine tips makes removal of lingual brackets so much easier and more comfortable for you and your patient.



Code

TEN380LG

NiTi Distal Cinch Back Pliers

Bends NiTi wire distal to the buccal tube for patient comfort. Serrated tips grip wire securely. Wire capacity .012" to .018".



Code

TEN802LG

Ligature Cutter/ Angled Ligature Cutter

Easy to use when cutting ligature wires/elastics. Angled option for easier access to lingual arches. Wire capacity up to .012".



Code

TEN331LG

TEN322LG (Angled)

Tenvis Lingual Wire Placer

Aids wire placement in lingual brackets whilst closing clips or ligating brackets. Specially shaped angled ends helps to maximise view. One single and one double end allows flexibility of use and the large diameter handle makes it easy to grip.

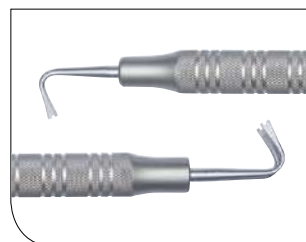

Code

TEN100LG

Tenvis™ Premium Hand Instruments

Manufactured from high quality stainless steel



- Ergonomically designed for maximum comfort and reduced muscle fatigue
- Textured grip for easy handling and control

Tenvis Explorer

Code

TEN220



Tenvis Ligature Director

Code

TEN221

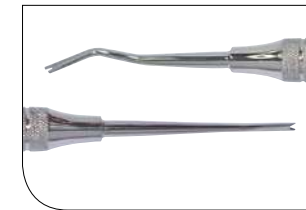

Tenvis Direct Bond Adhesive Remover

Code

TEN222



Tenvis Twirl-On Module

Code

TEN223

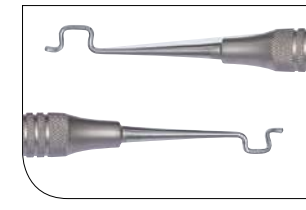

Tenvis Distal Bender, Double Ended

Code

TEN224



Mathieu Needle Holders

Made from high quality stainless steel with fine serrations for placing metal or elastic ties.

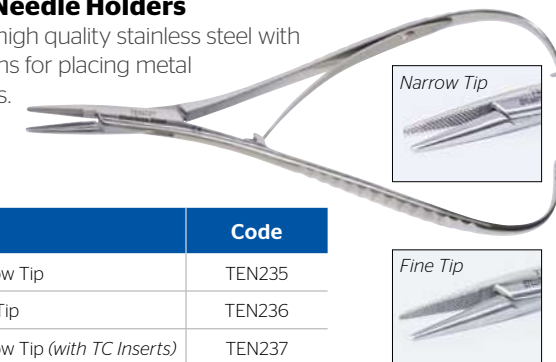

Product

Code

Mathieu Narrow Tip

TEN235

Mathieu Fine Tip

TEN236

Mathieu Narrow Tip (with TC Inserts)

TEN237

Direct Bond Tweezers

For bracket placement. Reverse action will not release the bracket until desired.

Code

TEN234



Direct Bond Tweezers with Bracket Aligner

Reverse action tweezer for placing brackets, with slot aligner on the opposite end.

Code

TEN233



Keat Buccal Tube Tweezers

For easy and accurate positioning of buccal tubes. Reverse action will not release the tube until required.

Product

Code

Keat Buccal Tube Tweezers

TEN230

Reverse Action Tweezers

TEN231



TN10 Bracket Positioner

Designed by UK orthodontist Dr. Russell Samuels the new TN10 has a hockey stick design on one end with millimetre measurements

Code

TEN520



Mosquito

Straight tip with a length of 12.5cm and a matt finish. Serrated tips provide a positive grip of elastomeric ligatures.

Code

TEN102



Essentials™ Instruments



Value Instrument Range

Essentials instruments are made of surgical grade stainless steel which is highly resistant to corrosion. The precise tip alignment and diamond honed edges ensures reliable cutting and holding of wires. Balanced joint assembly and well finished handles means Essentials instruments are easy and comfortable to use.

All Essentials instruments have an attractive satin finish so glare is reduced and the instruments have a pleasing quality look with no possibility of chrome plating peeling off. The cutters feature immunity steel tips for maximum performance. For safe use, cutting instruments are engraved with the maximum wire size to be used.

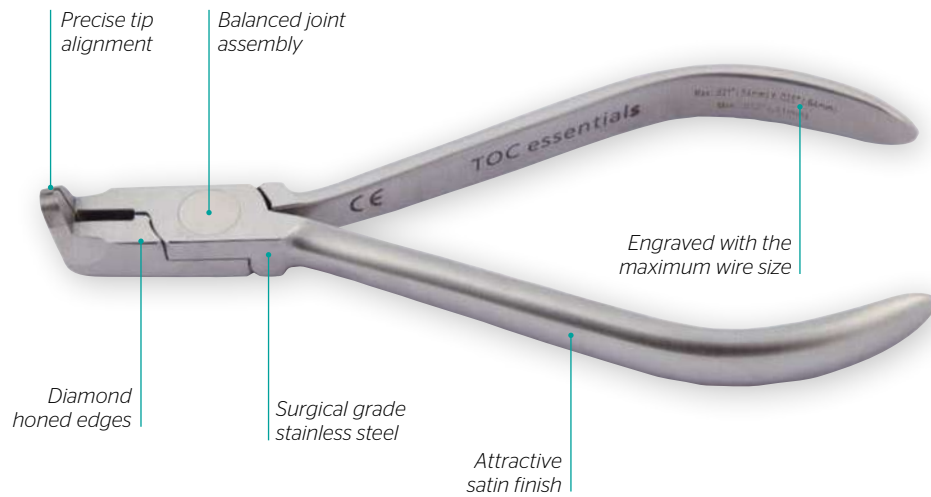

Value Cutters

Distal End Cutter

Safety hold cutters with immunity steel tips that will not discolour or rust. Cuts .018" x .025" and .022" hard wires.

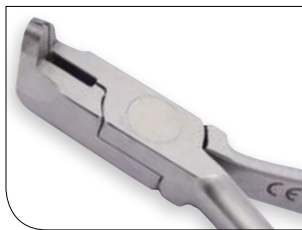

Code

TOC-E0319

Hard Wire Cutter

Specially designed for cutting hard wires. Cuts .022" x .028" and .022" hard wire.



Code

TOC-E0353

Pin and Ligature Cutter

A standard pin cutter with tips that have an ideal length of 12mm. Cuts .012" to .016".



Code

TOC-E0330

Adhesive Remover

Tip design allows access to remove adhesive in practically any area of the mouth. Replaceable teflon pad withstands high heat sterilisation.



Code

TOC-E0427

Straight Bracket Remover

Sharp tips wedge between the edge of the bracket base and tooth surface lifting off the bracket with no discomfort to the patient. The removers grip firmly for easy horizontal or vertical use.



Code

TOC-E0381

Angled Bracket Remover

Same as above, but angled for easy access to difficult posterior areas.



Code

TOC-E0380

Short Band Removers

The padded tip rests on the occlusal surface whilst the pointed tip catches the edge of the band for upward or downward removal. High heat replaceable pads available in 4, 5 and 6mm diameter.



Code

TOC-E0373

Long Band Removers

Same as TOC-E0373, but with a longer remover tip.



Code

TOC-E0371

Value Pliers

Weingart Plier

General utility plier with serrated tips to hold archwires firmly in the mouth. Angled for ease of working and good access.



Code

TOC-E0377

Slim Weingart Plier

General utility plier with slimmer tips for easier access to difficult areas. Serrated tips hold archwires firmly in the mouth.



Code

TOC-E0375

Three Jaw Plier

For adjusting clasps, retainers and archwires. With perfectly aligned tips which are tapered for delicate bending. Bends wire up to .030"



Code

TOC-E0385

Tweed Arch Forming

Designed for double back or triple back wire bending and can accommodate .030", .036" square wires. Also ideal for torquing.

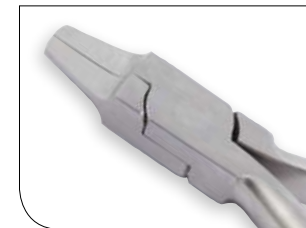

Code

TOC-E0412

Crimping Plier

Designed to crimp stops, hooks and posts to the archwire. The slot fits over the base of the hook while holding it tight for crimping.



Code

TOC-E0901

Cinch Back Plier

Cinches and bends NiTi archwires distal to the buccal tube. Slim beak allows precise working.



Code

TOC-E0802

Step Forming Plier

Make right or left, step up or step down bends in one simple action. Can be used intra-orally so no need to remove the archwire.



Size	Code
0.5 mm	TOC-E0712
0.75 mm	TOC-E0711
1 mm	TOC-E0710

Light Wire Plier

With tapered beaks for forming precise bends and loops in round archwires up to .020".



Code

TOC-E0392

How Utility Plier

Features straight serrated tips for a firm grip. Tips are 3mm diameter.



Code

TOC-E0432

Bird Beak Plier

Facilitates bending round wire up to .030". Features hardened tips.



Code

TOC-E0390

Adams 64 - Utility Plier

For adjusting orthodontic appliances.



Code

TOC-E0064

Adams 65

Square and rounded tips for forming springs and curves in wires.



Code

TOC-E0065

Essentials Hand Instruments



Value Range

Offering great value for money, the Essentials range of Hand Instruments are manufactured from high quality stainless steel and are resistant to corrosion.

Bonding Tweezer

Reverse action tweezer for placing brackets with slot aligner on the opposite end.

Code

TOC-E0450



Bonding Tweezer - Standard

For bracket placement. Reverse action will not release the bracket until desired.

Code

TOC-E0451



Bonding Tweezer - Fine Tips

Extra fine tips for extra visibility. With slot aligner on the opposite end.

Code

TOC-E0452



Keat Tweezer

For easy and accurate positioning of buccal tubes.

Code

TOC-E0454



Keat Reverse Action Tweezer

For easy and accurate positioning of buccal tubes. Reverse action will not release tube until required.

Code

TOC-E0455



Curved Bonding Tweezer

Ideal for placing lingual brackets and attachments. Reverse action.

Code

TOC-E0510



Band Pusher

With serrated tip to reduce risk of slippage. Light weight hollow handle for easy working.

Code

TOC-E0477



Mosquito

Straight tip with a length of 12.5cm. Grooved tip for placement of elastic ligatures.

Code

TOC-E0140



Ligature Director

Double ended light weight ligature director with textured grip.

Code

TOC-E0478



Separating Plier

Grooved beaks ensure a positive hold for positioning elastics. Angled tips for ease of access.

Code

TOC-E0585



Effer-ves®

Tablets for cleaning removable dental appliances

Provide your patients with a good cleaning regime from the start with the help of effer-ves. Used on a regular basis, effer-ves kills bacteria that can build up on aligners and other dental appliances as well as removing common stains caused by tea, coffee and some foods.

- Suitable for Clear Aligners, Clear Retainers, Wire Retainers, Mouthguards, TMJ Appliances, Bruxing Appliances and Nightguards
- Easy to use
- Safe to use on acrylic and wire combinations within orthodontic appliances

Product	Code
Patient Box (32 tablets/box)	TOC-ACT
Poster	TOC-ACTP
Leaflet Holder	TOC-ACTLH
Patient Leaflets	TOC-ACTPL



Ortho ReadyBrush™

A must have in any practice. Ready brushes come impregnated with mint toothpaste and are ready for use, just add water. Encourage your patients to brush before their appointment by offering them a Ready Brush. The V-Trim brush is designed specifically for ortho treatment to avoid interference with the appliance.



Product (Pk 30)	Code
Ortho ReadyBrush	TOC-ORB

4-Tufted Brush

Ideal for cleaning around wires and brackets, this small tufted shaped brush allows easier access than a normal brush head in hard to reach areas.



Product (Pk 12)	Code
4-Tufted Brushes	TOC-4TUFT

Ortho Hygiene Kit

A real quality hygiene kit to help promote good oral hygiene for those patients with fixed appliances. These sturdy, attractive Ortho Hygiene Kits are ideal for storage and travelling and are suitable for both teenagers and adults.



Product	Code
Pink	TOC-OKPK
Green	TOC-OKG
Blue	TOC-OKB
Purple	TOC-OKP

Includes:

- V-Trim Toothbrush
- Travel Brush
- End Tuft Brush
- Mirror
- Toothpaste
- Interdental Brush
- Wax
- Timer

Appliance Cases

Slim design ideal for aligners, whitening trays and retainers. Try our pack of assorted colours so you have a colour to suit everyone!

- Strong & compact
- 1" Depth
- Positive lock hinged lid
- Vented
- Economical

Product (Pk 12)	Code
Pink	TOC-RCPK
Blue	TOC-RCB
Coral	TOC-RCC
Green	TOC-RCG
Yellow	TOC-RCY
Orange	TOC-RCO
Purple	TOC-RCP
Red (Pk 10)	TOC-RCR
White	TOC-RCW
Assorted	TOC-RCA
Assorted Sparkle	TOC-RCS



Patient Relief Wax

Plain wax in scented and coloured cases. Provides instant relief for your patients from the irritation of their fixed appliance.

Product (Pk 50)	Code
Grape	PW-001-50
Orange	PW-002-50
Cherry	PW-003-50
Cinnamon	PW-004-50
Mint	PW-005-50
Bubble Gum	PW-007-50
Pineapple	PW-008-50
Blueberry	PW-009-50
Cotton Candy	PW-013-50
Silver (Unscented)	PW-010-50



A
 Adhesives.....23-24
 Aesthetic Archwires.....13
 Alginate.....26
 Appliance Cases.....37
 Appliance Cleaner.....37
 Archwires.....11-16
 Archwire Stops, Hooks.....19
 Attachments.....18

B
 Ball Hooks.....19
 Bands & Buccal Tubes.....9-10
 Band Cement.....23
 Beta Titanium Archwires.....13, 15
 Bi-Directional Hooks.....19
 Bondable Buccal Tubes.....10
 Bondable Buttons, Eyelets.....18
 Bonding Adhesives.....23-24
 Boxes, Retainer.....37
 Bracket Systems
 Ceramic.....3-4
 Composite.....5
 Stainless Steel.....6-8
 Buccal Tubes.....10
 Burs.....29
 Buttons, Composite, Stainless Steel.....18

C
 Carbide Debonding Burs.....29
 Cases, Retainer.....37
 Cement, Band.....23
 Ceramic Brackets.....3-4
 Ceramic Buttons, & Hooks.....18
 Chain, Elastomeric.....21
 Cheek Retractors.....24-25
 Cleaning Tablets.....37
 Coated Ties.....17
 Coated Wires.....13
 Coaxial Wire.....17
 Coil Springs, Open, Closed.....16-17
 Composite Buttons.....18
 Composite Brackets.....5
 Composite Removal Burs.....29
 Copper NiTi archwires.....12
 Crimpable Hooks & Stops.....19
 Crimping Pliers.....31, 35
 Cutting Instruments.....30, 32, 34

D
 Debonding Burs.....29
 Diamond Strips.....29
 Distalizing Springs.....16
 Double-Ended Photo Cheek Retractors.....24

E
 Effer-ves Appliance Cleaner.....37
 Elastics.....22
 Elastic Thread.....21
 Elast-O-Loop Separators.....21
 Elastomeric Ligatures & Chain.....20-22
 Envy Composite Brackets.....5
 Essentials Archwires.....16
 Essentials Buccal Tubes.....10
 Essentials Instruments.....34-36
 Essentials Metal Brackets.....8

Essentials Pre-Welded Bands.....9
 Etch.....24
 Extra-Oral Elastics.....22
 Eyelets.....19

G
 Ghost Ceramic Brackets.....3

H
 Hand Instruments.....33, 36
 Hi-Q Archwires.....11-15
 Hooks, Crimpable.....19
 Hygiene Kits.....37

I
 Impression Trays.....26
 Instruments.....30-36
 Interproximal Stripping.....29
 Intraoral Elastics.....22

K
 Kobayashi Ligatures.....17

L
 Latex Free Elastomers & Chain.....20-22
 Ligature Ties, Preformed.....17
 Ligatures, Elastomeric.....20
 Light Cure Adhesive.....23
 Light Cure Band Cement.....23
 Lingual Debonding BUs.....29
 Lingual Instruments.....32
 Lingual Wires.....15
 Lip Retractors.....25

M
 Metal Brackets.....6-8
 Mighty Links.....20
 Mighty Ties, Chain.....20-21
 Mirrors.....27
 Molar Bands.....9
 Mosquitos.....36

N
 Nickel Titanium Archwires.....11, 13, 15-16
 Nickel Titanium Springs, Open, Closed.....16-17

O
 Ortho Hygiene Kit.....37
 Ortho Ready Brush.....37

P
 Patient Hygiene Kits.....37
 Photo Cheek Retractors.....24-25
 Photographic Mirrors.....27
 Pliers, Cutters.....30-36
 Porcelain Primer.....24
 Posted Archwires.....14
 Precision Aligner Buttons.....18
 Pre-Welded Molar Bands.....9
 Pure Plastics.....28

Q
 Quantum Burs, Strips.....29

R
 Radiopaque Separators.....21
 Relief Wax.....37
 Replicate Alginate.....26
 Retainer Cases.....37
 Retainer Cleaner.....37
 Retainer Material.....28
 Retractors.....24-25
 Reverse Curve Archwire.....12
 Rotation Wedges.....21

S
 Separators.....21
 Shorty Ligature Ties.....17
 Springs, Open, Closed.....16-17
 Stainless Steel Archwires.....14-15
 Stainless Steel Brackets.....6-8
 Stainless Steel Ties.....17
 Stops, Crimpable.....19
 Stripping, Interproximal.....29

T
 Thermal NiTi Archwires.....11, 13, 15-16
 Tervis Hand Instruments.....33
 Tervis Labial Instruments.....30-31
 Tervis Lingual Instruments.....32
 Ties, Elastomeric.....20
 Ties, Kobayashi.....17
 Ties, Kobayashi Shorty.....17
 Ties, Preformed Ligature.....17
 Ties, Preformed Shorty.....17
 Tooth Coloured Ties.....17
 Tooth Coloured Wires.....13
 Travel Kit, Hygiene.....37
 Tru-Grip Band Cement.....23
 Tru-Grip Bracket Adhesive.....23
 Tru-Grip Etch.....24
 Tungsten Carbide Debonding Burs.....29
 Tweezers.....33, 36

U
 Universal Archwires.....11-12, 15

V
 Verve Buccal Tubes.....10
 Verve Ceramic Brackets.....4
 Verve Metal Brackets.....6
 Verve Prewelded Bands.....9

W
 Whitening Tray Material.....28
 Wire Products.....11-17
 Woodland Creatures Elastics.....22

Terms & Conditions

Prices

All prices quoted are exclusive of VAT and Carriage. There is no minimum order charge. TOC reserves the right to change price details as it may deem necessary without prior notice and without incurring obligation. E&OE.

Payment

Payment is to be made by credit card in advance of orders being shipped.

Delivery

Each delivery will contain a delivery note or invoice. On receipt of goods customers are requested to ensure the goods are as required before breaking any packaging or seal. Shortages or breakages must be notified to TOC within 3 days of receipt.

Quality

TOC operates a Quality Management System which conforms to all current quality and regulatory standards. This incorporates a Batch/Lot Control System for traceability of all medical devices and equipment dispatched by TOC. Customers should retain information for products supplied by TOC including Batch/Lot No. and expiry dates.

Continuing Product Improvement

Due to continuing product improvement TOC reserves the right to modify, improve and change product specification and to discontinue products without advance notice and without incurring obligation. We are not responsible for typographical or photographic errors and we reserve the right to limit quantities.

No part of TOC's catalogue, literature or website may be reproduced in any form without the permission of TOC.

All images are for illustration purposes only. All trademarks are the property of their respective owners. E&OE. TOC adheres to GDPR protocols.

Returns

All credits and returns are issued at the discretion of TOC Head Office. Customers must in the first instance call TOC Export Manager for authorisation with details of products to be returned and reasons for the return.

Under the following conditions, customers may return for credit any stock product with which they are not satisfied:

1. Products must be returned within 30 days of purchase.
2. Products must be standard catalogue items in an unopened condition and will only be accepted back from the original purchaser.
3. Written explanation must accompany the goods, stating the reason for dissatisfaction and quoting the original invoice number.
4. Returned goods must be adequately packaged to withstand delivery and carriage must be prepaid by the customer with contents insured to the full invoice value. TOC is unable to credit returned goods lost or damaged in transit.
5. All products must be in a new and resaleable condition, of current design and in its original packaging. According to CE regulations, items returned opened must be regarded as "used" and cannot therefore be accepted back for credit.
6. TOC reserves the right to charge a 15% restocking fee.
7. Special customer ordered products such as prewelded bands are non-returnable.

Cancellations

TOC reserves the right to cancel an order or balance of order without liability. Customers are not able to cancel orders without the agreement of TOC. A charge may be made to cover costs already incurred where special items are cancelled.

Law

These terms and conditions shall be governed by and construed in accordance with the law of England and the parties hereby submit to the exclusive jurisdiction of the English courts.



*Thank you for choosing
 TOC for your orthodontic
 requirements*



*TOC versions of Roth and MBT prescriptions are not implied to be an exact version of any other system, nor do we claim any endorsement of the Doctors. © TOC. All Rights Reserved. January 2019.

T: +44 117 975 5533
F: +44 117 975 5575
E: info@tocdental.com
W: www.tocdental.com

TOC, Collins Street, Avonmouth, Bristol BS11 9JJ UK